nexoDAQ-7620

**Wireless Universal
Analog Measurement Device**

User Manual

v1.0.0





Contents

| | | |
|----------|--|-----------|
| 1 | Introduction | 4 |
| 2 | Setup | 5 |
| 2.1 | System Description | 5 |
| 2.2 | Gateway Front and Back Panes | 6 |
| 2.3 | nexoDAQ Front and Back Panes | 7 |
| 2.3.1 | The Front Pane | 7 |
| 2.3.2 | The Back Pane | 9 |
| 2.4 | Powering | 11 |
| 2.5 | Calibration | 11 |
| 2.6 | Connecting the Sensors | 12 |
| 2.6.1 | ± 10 V Differential Signals | 13 |
| 2.6.2 | ± 10 V Single Ended Signals | 14 |
| 2.6.3 | Full Bridge | 15 |
| 2.6.4 | ± 100 V Signals | 16 |
| 2.6.5 | IEPE / ICP [®] sensors | 17 |
| 2.6.6 | Differential Charge Signals | 18 |
| 2.6.7 | Single Ended Charge Signals | 19 |
| 2.6.8 | Current Loop (4-20 mA) Signals | 20 |
| 2.7 | Installing the Application | 21 |
| 2.7.1 | Windows | 21 |
| 2.7.2 | Linux | 21 |
| 2.7.3 | macOS | 22 |
| 3 | Inertia Studio | 23 |
| 3.1 | Main Screen | 23 |
| 3.1.1 | Toolbar and Menu | 24 |
| 3.1.2 | Plots | 26 |
| 3.1.3 | Information Area | 27 |
| 3.2 | Connecting to a Device | 29 |
| 3.2.1 | Connecting to a Device Using the Toolbar | 29 |
| 3.2.2 | Connecting to a Device Using the Menu | 29 |
| 3.3 | Logging to File | 31 |
| 3.4 | Logging to Flash | 33 |
| 3.4.1 | Starting and Stopping a Flash Log | 33 |
| 3.4.2 | Downloading a Flash Log | 34 |
| 3.4.3 | Deleting Flash Logs | 35 |
| 3.5 | Filling in Lost Samples | 36 |
| 3.5.1 | Automatic | 36 |



| | | |
|----------|---|-----------|
| 3.5.2 | Manual | 37 |
| 3.6 | Exporting a Logfile | 38 |
| 3.6.1 | CSV Settings | 39 |
| 3.6.2 | MAT Settings | 40 |
| 3.6.3 | Visual3D Settings | 41 |
| 3.6.4 | ITLOG Settings | 41 |
| 3.7 | Replaying a Logfile | 42 |
| 3.7.1 | Real-Time | 42 |
| 3.7.2 | Analysis | 43 |
| 3.8 | Configuring the Sensors | 45 |
| 3.8.1 | Global Settings | 46 |
| 3.8.2 | Channel Settings | 48 |
| 3.8.3 | Status Settings | 58 |
| 3.8.4 | Sampling Channels | 59 |
| 3.9 | I/O Functionality | 60 |
| 3.9.1 | Trigger Output | 60 |
| 3.9.2 | Trigger Input | 61 |
| 3.9.3 | Sync Output | 61 |
| 3.9.4 | Sync Input | 62 |
| 3.10 | The Tracker | 63 |
| 3.11 | GNSS Map | 63 |
| 3.12 | Appearance and Preferences | 63 |
| 3.12.1 | Layout Configuration | 63 |
| 3.12.2 | Preferences | 65 |
| 3.13 | Updating the Firmware | 71 |
| 4 | Performing an Experiment | 73 |
| 4.1 | Basic steps for making an experiment with <i>nexoDAQ</i> | 73 |
| 4.2 | Reading and Aligning CSV Log Files | 80 |
| 5 | Troubleshooting | 82 |
| 5.1 | Retrieving an Unreachable Device | 82 |
| 5.2 | Slow Signals in Inertia Studio | 82 |
| 5.2.1 | Lowering the Plot Update Speed | 82 |
| 5.2.2 | Reducing the Number of Plots or Nodes | 82 |
| 5.2.3 | Enabling Hardware Acceleration and Multi-threaded Rendering | 82 |
| 5.3 | Manually Installing the Inertia Driver | 83 |



1 Introduction

The *nexoDAQ-7620* is a wireless dynamic universal analog measurement device designed for many different applications, ranging from high-speed measurements to low-power monitoring. It is modular, versatile and highly configurable.

The *nexoDAQ-7620* is equipped with three 24-bit data acquisition channels that can be software configured to interface various types of sensors: ± 10 V differential signals, ± 10 V single-ended signals, ± 100 V signals, full bridge, current loop (4-20 mA) signals, IEPE/ICP[®] sensors, differential charge signals and single-ended charge signals.

The *nexoDAQ-7620* achieves real-time wireless data acquisition at data rates reaching 10 kHz per channel. The wireless protocol stack operates in the 2.4 GHz frequency band. Multiple measurement devices form a network and report measurement data synchronized within less than 100 ns. The data can also be communicated over USB or Ethernet, or be stored locally on the on-board flash storage and retrieved later over wire or wirelessly.

In the highest power consumption mode, *nexoDAQ-7620* achieves a running time of 2 hours of continuous sampling and communication. Alternatively, it can be powered from external sources, such as 24V standard industrial or 5V USB charger.

The *nexoDAQ-7620* is rugged IP67 and has industrial operating range.

Information about warranty and liability can be found at: <https://inertia-technology.com/terms-and-conditions/>.



Figure 1: The *nexoDAQ* measurement device



2 Setup

This section describes the high-level system setup.

2.1 System Description

The system consists of a number of *nexoDAQ-7620* devices, the Advanced Inertia Gateway, and the PC software (Inertia Studio) for configuring, monitoring and logging the sensor data. A *nexoDAQ-7620* device is referred throughout this document also as '*nexoDAQ* device', 'device', 'sensor node' or 'node'. The Advanced Inertia Gateway is referred throughout this document also as 'gateway'.

The setup is depicted in Figure 2. The *nexoDAQ* devices communicate wirelessly with the Advanced Inertia Gateway, using the Inertia high-speed wireless protocol. The gateway is connected through the mini-USB connector or the Ethernet connector with a computer that runs the Inertia Studio software. The Advanced Inertia Gateway can synchronize to external systems using trigger and clock signals, see Section 3.9.

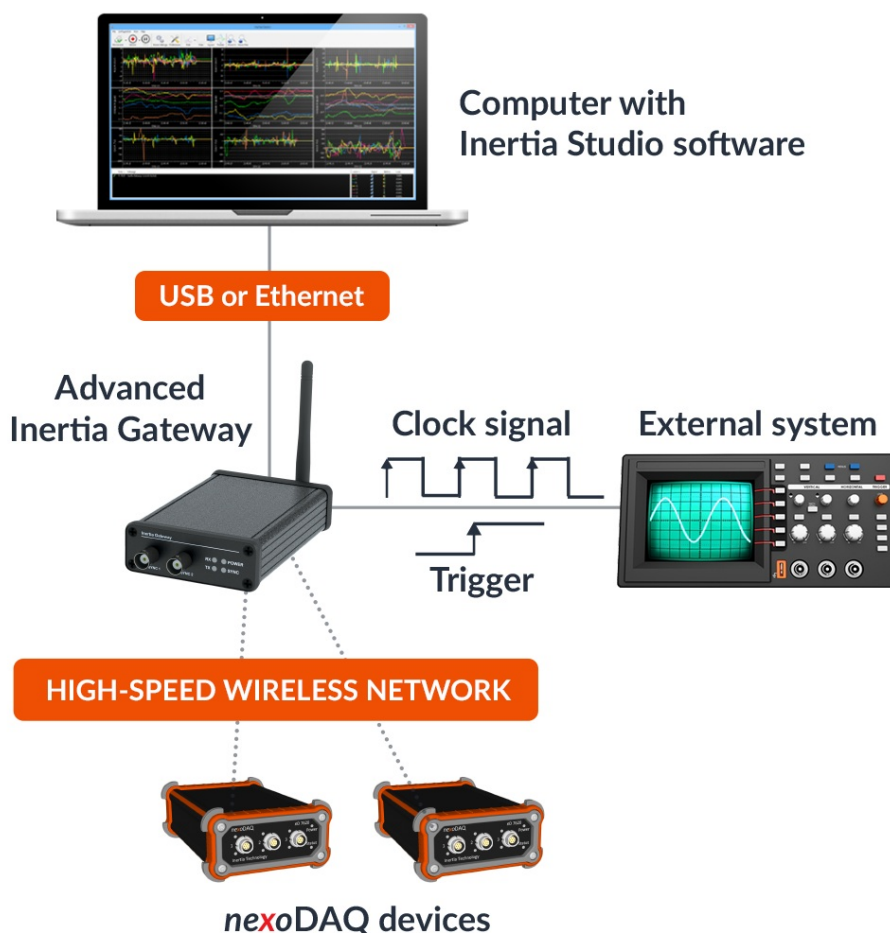

Figure 2: Typical system setup



2.2 Gateway Front and Back Panes

Figure 3 shows the front and back of the Advanced Inertia Gateway. On the front, the gateway has two BNC connectors and four blue LEDs with the following functionality:

- **RX:** The gateway is receiving data.
- **TX:** The gateway is transmitting data.
- **Power:** The gateway is powered on.
- **Sync:** The gateway is synchronized with an external signal.

The *EXT SYNC 1* and *EXT SYNC 2* connectors can be configured as *Input* or *Output*, with either *Trigger* or *Sync* functionality. See Section 3.9 for more information.

The backside contains a DC power connector, antenna, mini-USB connector and an *100BASE-TX* Ethernet connector. The gateway can be connected using the mini-USB or the Ethernet connector to the PC.

When using the Ethernet connector, the gateway can be connected directly to the network adapter of the PC using an Ethernet cable, or to a (wireless) switch/router in the same local network as the PC. Inertia Studio requires Npcap or WinPcap on Windows and libpcap on Linux and macOS to access the network adapter and receive the Raw Ethernet data. The gateway has a local MAC address based on its serial number, e.g. 02:34:56:78:xx:xx, where xx:xx is the serial number. The gateway sends its data to broadcast address ff:ff:ff:ff:ff:ff using EtherType protocol 0xbabe.



Figure 3: The front and back of the Advanced Inertia Gateway

2.3 nexoDAQ Front and Back Panes

2.3.1 The Front Pane

The front pane (Figure 4) provides connections for three analog inputs, used for the connection of external sensors. Each analog input has two associated LEDs, the **Channel LED High** and the **Channel LED Low**. Additionally, there are two other LEDs, the **Power** and the **Status** LEDs. Each LED can light up in two colors, red and green. The color code for each LED is described below.

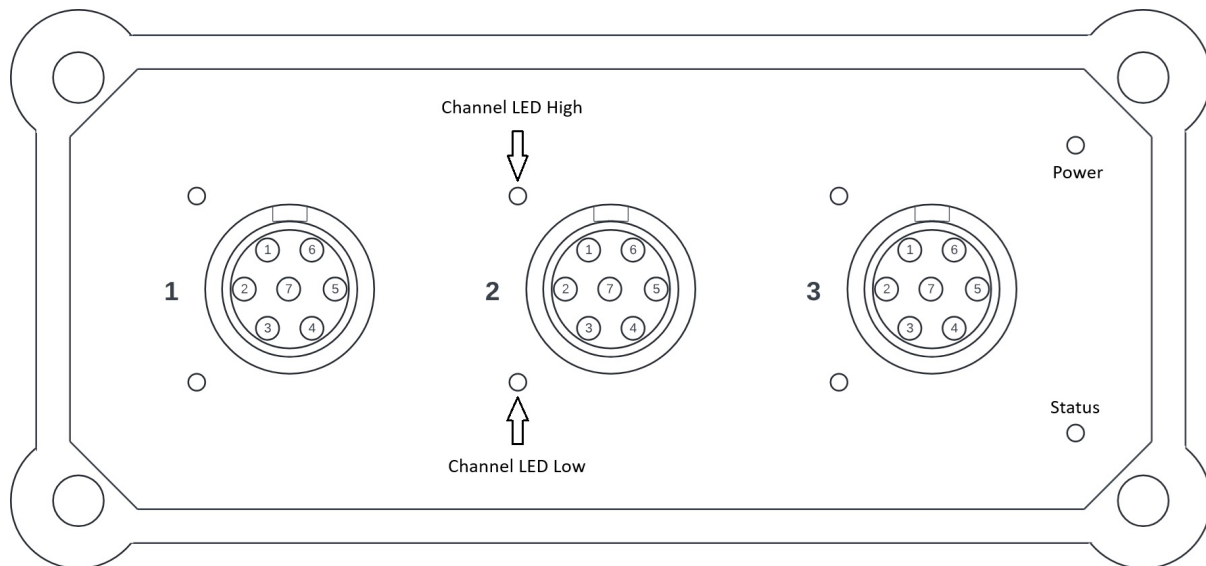

Figure 4: The frontside connections of the *nexoDAQ* device

- **Power**
 - Green: Powered, not charging.
 - Solid red: Powered, charging.
 - Blink red (1s every 5s): Off, charging.
- **Status:**
 - Red: Communication (USB/Wireless).
 - Green: Unassigned.
- **Channel LED High:**
 - Red: Channel configured, not sampling.
 - Green: Channel configured and sampling.
- **Channel LED Low:**
 - Unassigned.



Figure 5 shows the frontside panel of the *nexoDAQ* device, powered and not charging (the **Power LED** is green), where the analog inputs are connected and sampling (all **Channel LED High** LEDs are green) and there is wireless communication with the gateway (the **Status LED** is red).



Figure 5: *nexoDAQ* front panel with sensors connected and wireless communication

2.3.2 The Back Pane

On the back pane there is a barrel connector for power supply, a micro-USB connector for the communication with a PC, an SMA connector for an antenna, enabling wireless communication with the Inertia Gateway, and the power button, as shown in in Figure 6.

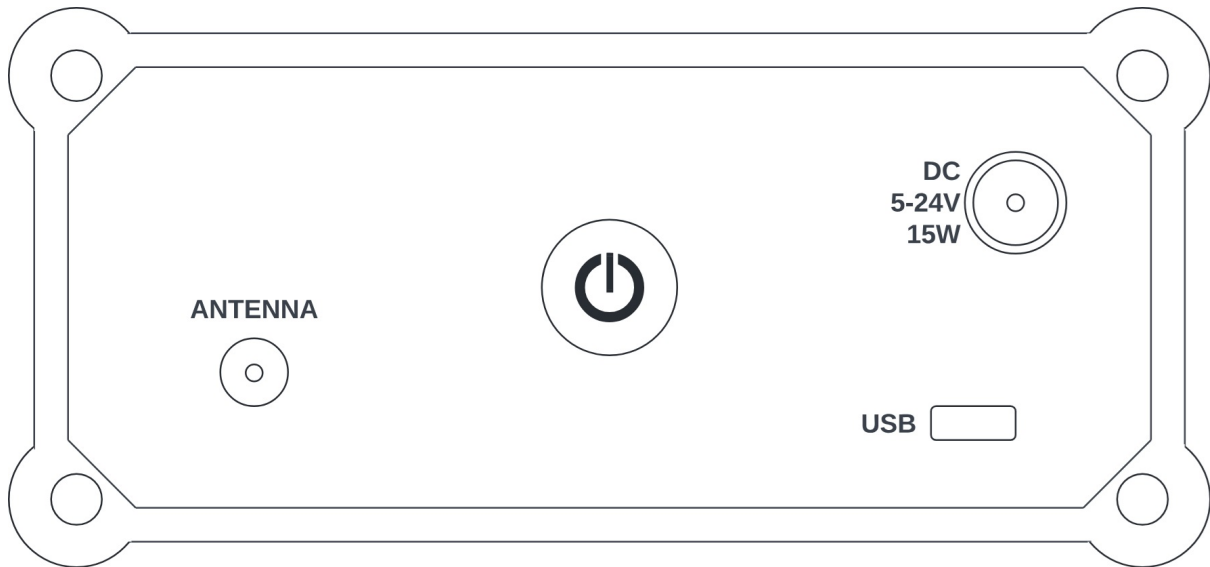

Figure 6: The backside connections of the *nexoDAQ* device

Figure 7 shows the backside panel of the *nexoDAQ* device with the power button highlighted. The connectors for power, micro-USB and antenna are also visible.



Figure 7: *nexoDAQ* back panel with power, micro-USB and antenna connectors, and the power button



2.4 Powering

The *nexo*DAQ can be powered from an external power supply, from the micro-USB connector and from the internal battery.

The 2.5 mm ID/5.5 mm OD barrel connector is used when connecting to the external power input, as shown by the schematics in Figure 8. The voltage for the external power input ranges from 5 to 24 V. However, it is recommended to use a voltage above 7V, especially when charging a depleted battery.

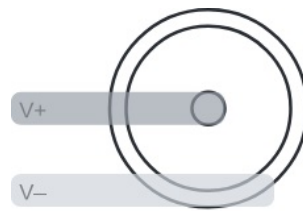

Figure 8: The barrel connector for external power supply

The micro-USB connector is used to make a connection with the computer for data transfer or to a USB power adapter for recharging the batteries. Please note that the current supplied from the computer using the micro-USB connector is not sufficient for operating the device in full-power mode. Therefore, it is necessary to use an external power input or the internal battery will be drained.

The internal battery of the *nexo*DAQ device should be periodically recharged. It is recommended to use the external power supply or the micro-USB connected to a wall adapter. During recharging keep the device turned off. Monitoring the battery voltage can be done using Inertia Studio (see paragraph 3.1.3.2). When the battery is empty the device will automatically turn itself off.

The gateway has no internal battery and therefore does not require recharging.

2.5 Calibration

The *nexo*DAQ is calibrated over a range of temperatures and for at least two levels of supply voltage.

The *nexo*DAQ calibration applies a set of correction factors to various aspects of the signal path for different frontends over a temperature range from -10°C to 30°C. This calibration is necessary because both the silicon leakage and the FET resistances strongly depend on temperature. Therefore, the offset, the gain and the optional 200 Ohm input shunt resistor are temperature-dependent. The calibration is carried out in a temperature chamber and the calibrations are performed at fixed temperature steps.

Additionally, the signal path supply voltage has also an effect on the offset and gain. Calibration is therefore performed for at least two levels of supply voltage. The calibration values



form a two-dimensional space (temperature and supply voltage) within which the *nexoDAQ* interpolates to get to any point in that space.

2.6 Connecting the Sensors

The *nexoDAQ* provides connections for three analog inputs on the front, used for connecting external sensors (see Section 2.3.1). This section describes how the various sensors are connected to the *nexoDAQ* analog inputs. For information on how to configure these sensors in the Inertia Studio software, see Section 3.8.

nexoDAQ analog inputs can be connected using the cables provided along with the device. These cables with 7 wires have on one end the *Lemo* circular connector with 7 contacts and on the other end a *pigtail* connector.

The *Lemo* circular connector can be inserted into one of the *nexoDAQ* analog inputs. When inserting the connector into the analog input, attention has to be paid such that the **red dot** on the connector points upwards (Figure 9).

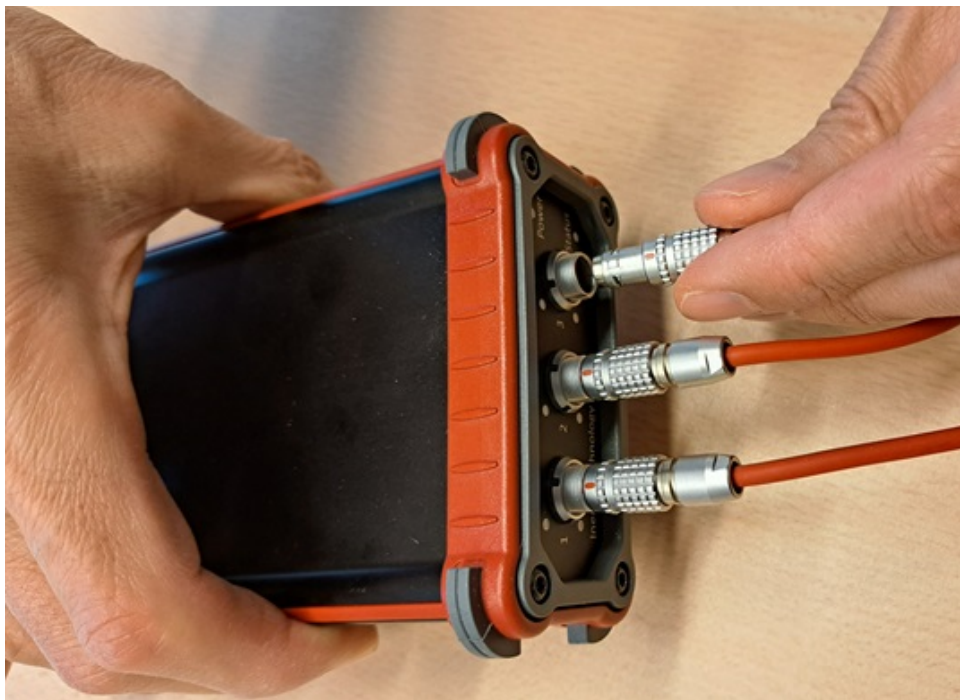
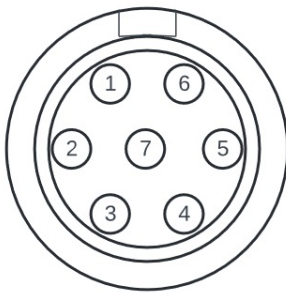

Figure 9: Connecting the *Lemo* connectors to *nexoDAQ* analog inputs

The *pigtail* is used for connecting the various sensors to *nexoDAQ*. Table 1 describes the corresponding pin assignments of the *nexoDAQ* device.

In the following, we present the wire connections needed for the different sensors that can interface with *nexoDAQ*.

Table 1: Pin assignments of the *nexoDAQ* device



| Pin | Assignment | Description |
|-----|------------|------------------------------|
| 1 | EX- | Negative excitation output |
| 2 | T2 | TEDS Class 2 |
| 3 | AIN- | Negative analog input |
| 4 | AIN+ | Positive analog input |
| 5 | GPIO | General Purpose Input/Output |
| 6 | EX+ | Positive excitation output |
| 7 | GND | Signal ground |

2.6.1 ± 10 V Differential Signals

You can connect ± 10 V differential signals to the *nexoDAQ*, as shown by the schematics in Figure 10. The *nexoDAQ* optionally provides positive and negative sensor excitation up to 30 V.

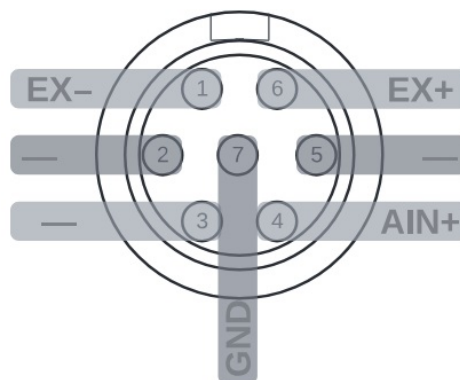
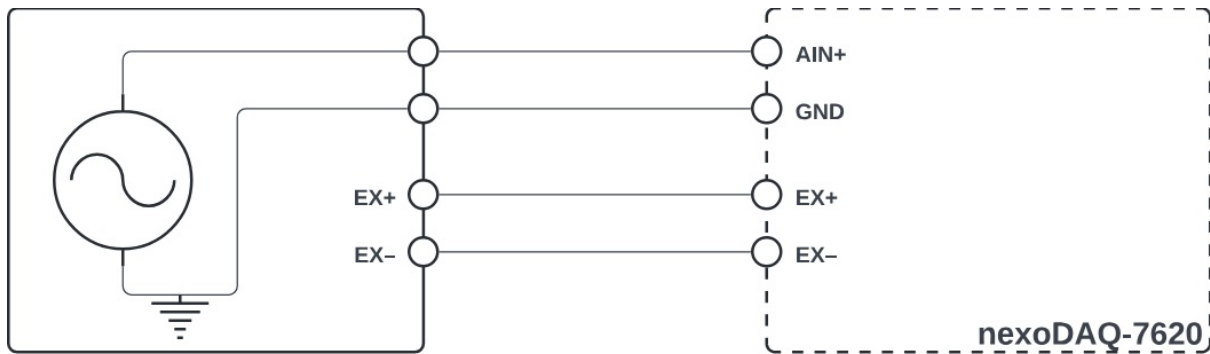

Figure 10: Connecting ± 10 V differential signals

2.6.2 ± 10 V Single Ended Signals

You can connect ± 10 V singled ended signals to the *nexoDAQ*, as shown by the schematics in Figure 11. When using this setup the AIN- input on the *nexoDAQ* must be connected to GND. The *nexoDAQ* optionally provides positive and negative sensor excitation up to 30 V.

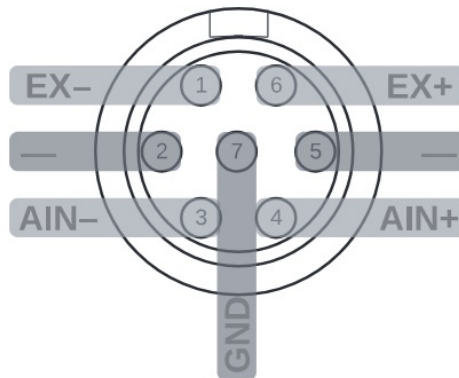
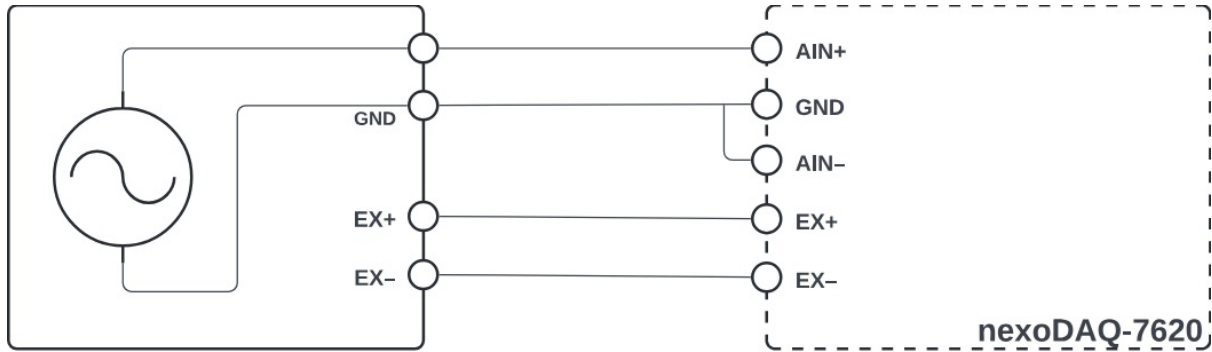

Figure 11: Connecting ± 10 V single ended signals

2.6.3 Full Bridge

You can connect a full bridge to the *nexoDAQ*, as shown by the schematics in Figure 12. The *nexoDAQ* optionally provides bridge excitation from 5 V up to 30 V with a maximum load current of 25 mA.

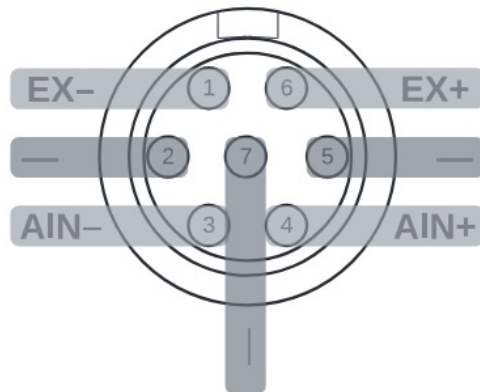
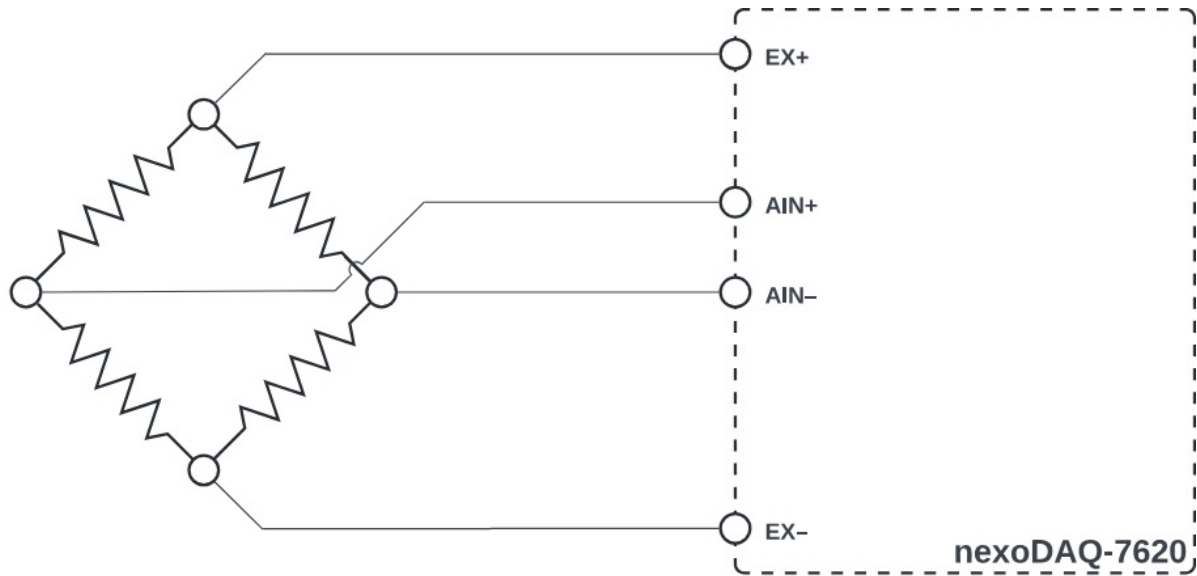

Figure 12: Connecting a full bridge

Note: When a lower excitation voltage is required use GND instead of EX-. This reduces the excitation voltage range to 2.5 V up to 15 V.

2.6.4 ±100 V Signals

You can connect ±100 V signals to the *nexoDAQ*, as shown by the schematics in Figure 13. The *nexoDAQ* optionally provides positive and negative sensor excitation up to 30 V.

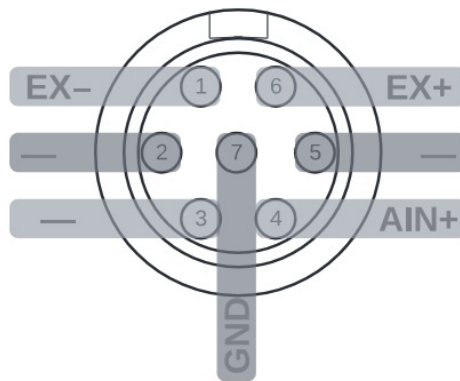
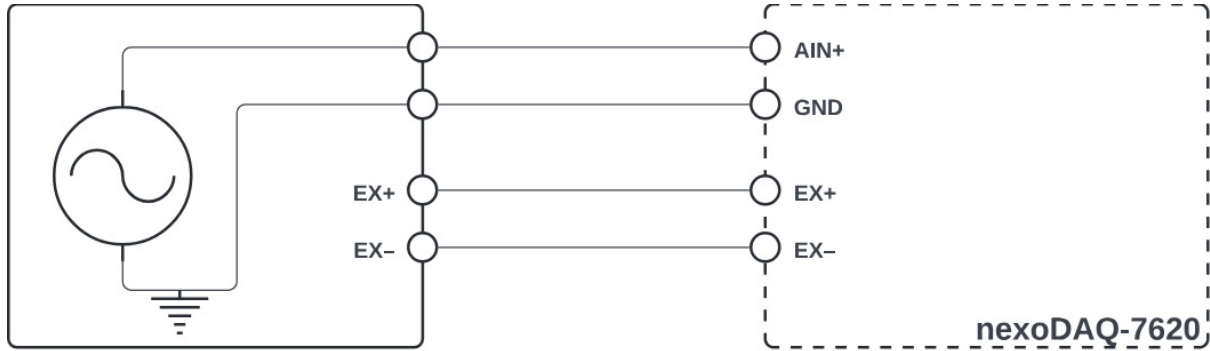

Figure 13: Connecting ±100 V signals

2.6.5 IEPE / ICP© sensors

IEPE/ICP© sensors are active sensors that require a constant current supply. The sensor in turn modulates the voltage with the sensed signal around a bias voltage.

You can connect IEPE sensors to the *nexoDAQ*, as shown by the schematics in Figure 14. The *nexoDAQ* has a built-in excitation current source for each channel.

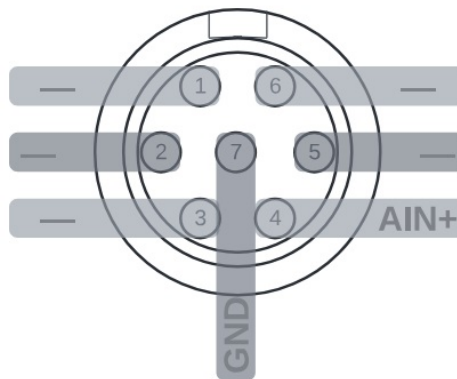
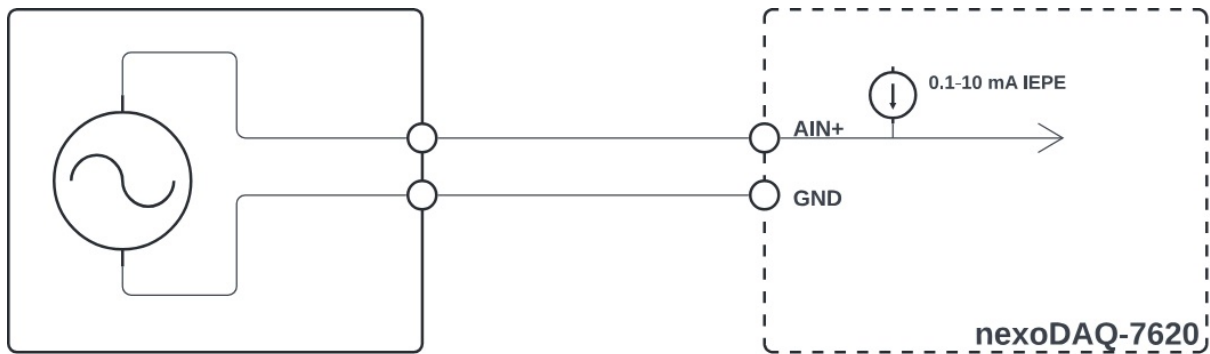

Figure 14: Connecting IEPE / ICP© sensors

2.6.6 Differential Charge Signals

You can connect differential charge signals to the *nexoDAQ*, as shown by the schematics in Figure 15.

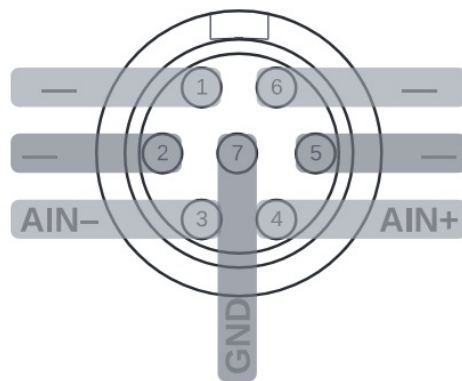
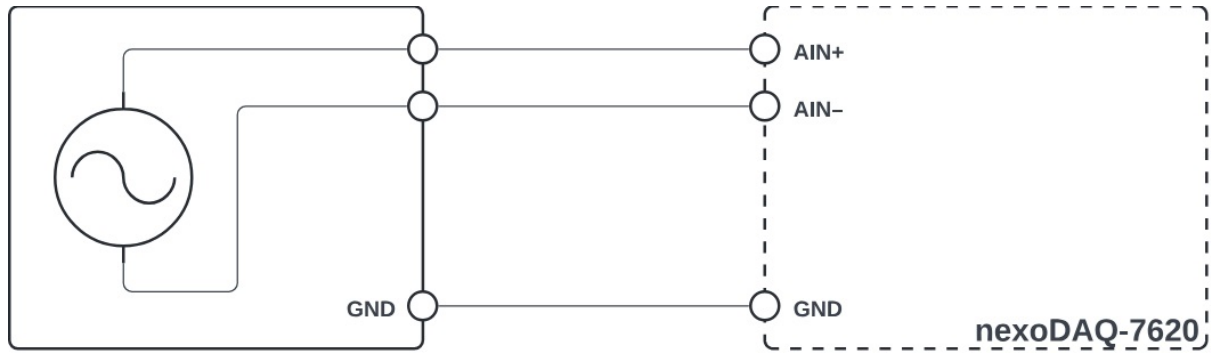

Figure 15: Connecting differential charge signals

2.6.7 Single Ended Charge Signals

You can connect single ended charge signals to the *nexoDAQ*, as shown by the schematics in Figure 16. When using this setup the AIN- input on the *nexoDAQ* must be connected to GND.

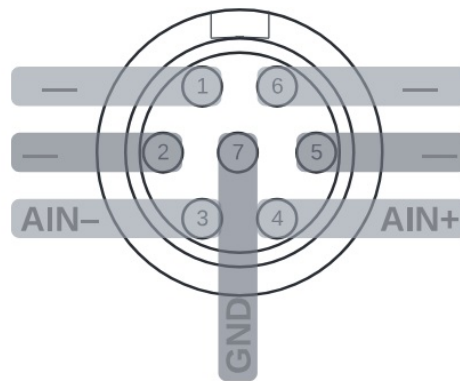
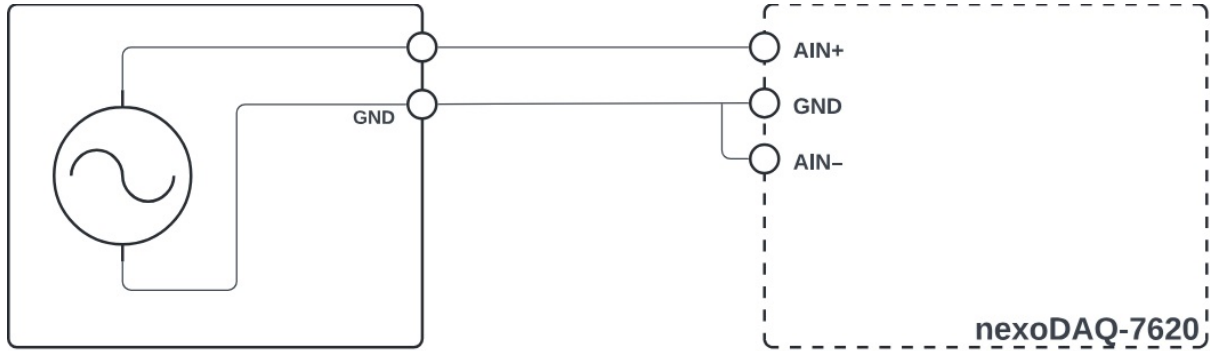

Figure 16: Connecting single ended charge signals

2.6.8 Current Loop (4-20 mA) Signals

You can connect current loop signals to the *nexoDAQ*, as shown by the schematics in Figure 17. The *nexoDAQ* optionally provides current loop sensor excitation up to 15 V.

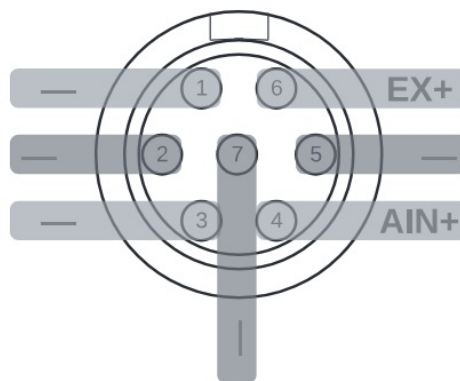
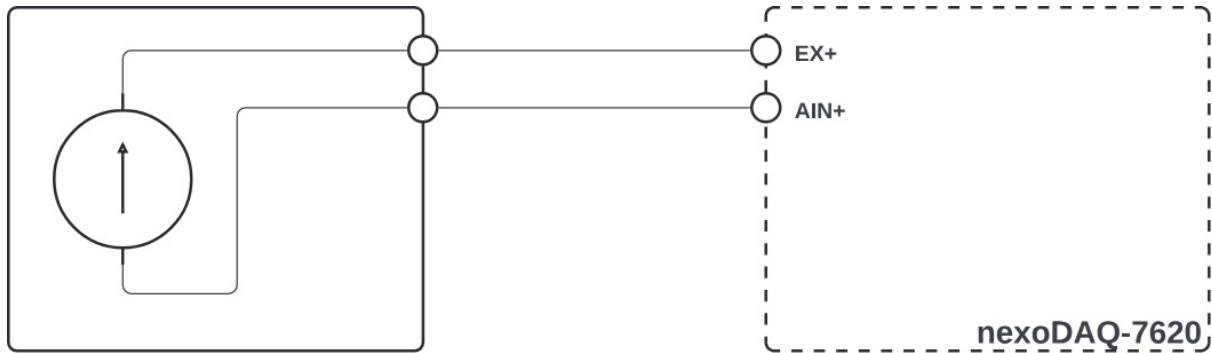

Figure 17: Connecting a current loop signals



2.7 Installing the Application

This section explains the installation of the Inertia Studio application on various operating systems. For information on performing an measurement with *nexoDAQ*, please see Section 4.

The Ineria Studio application runs under Windows, Linux and macOS operating systems. In the following, we describe the installation procedure in each of these environments.

2.7.1 Windows

On a Microsoft Windows computer, unzip and run the Inertia Studio setup executable. During the setup process, the Inertia driver and the Visual C++ redistributable are installed (Figure 18). This may require a computer reboot. Choose a destination folder and press the **Install** button (Figure 18).

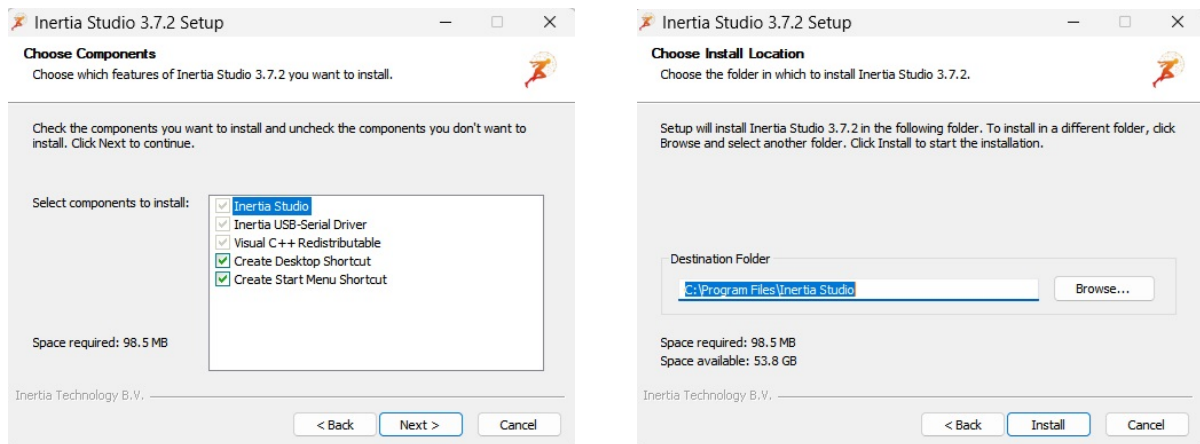

Figure 18: Inertia Studio installation in Windows

2.7.2 Linux

In Linux Ubuntu, install the package with the following command:

```
sudo dpkg -i inertiastudio-[version].deb
```



2.7.3 macOS

On a macOS device, open the *.dmg file as follows:

- On an *Apple silicon* device, open the *arm64* version of the *.dmg file.
- On an *Intel* device, open the version without *arm64* in the *.dmg file name.

Afterwards, drag the Inertia Studio application to the Applications, as shown in Figure 19.



Figure 19: Inertia Studio installation in macOS



3 Inertia Studio

Inertia Studio can be used for realtime visualization of sensor data, logging of sensor measurements and pre-computed orientation, and configuration of sensor and wireless parameters. This section describes Inertia Studio (v3.7.1) in more detail.

Inertia Studio is available for Microsoft Windows, Ubuntu Linux and macOS.

3.1 Main Screen

Figure 20 shows the main screen of Inertia Studio, which is divided in the following areas:

- The menu and toolbar at the top (described in Section 3.1.1)
- The sensor data plots in the middle (described in Section 3.1.2)
- The information area at the bottom (described in Section 3.1.3)

In the following, these three areas are presented in detail.

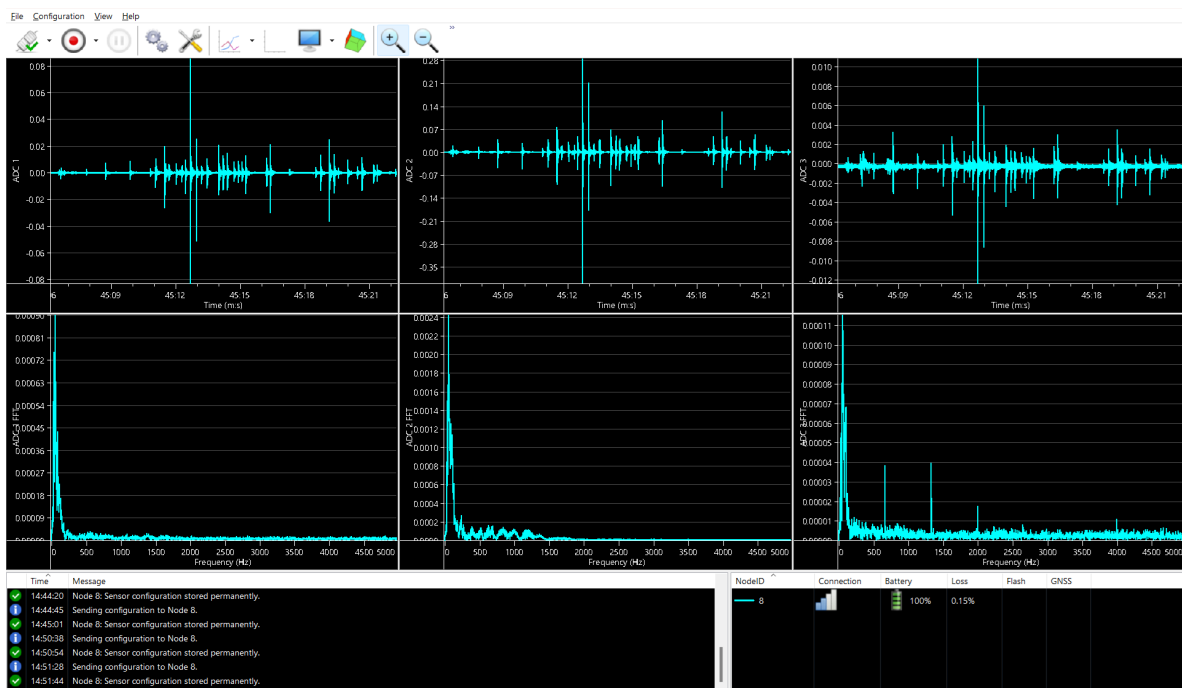

Figure 20: Inertia Studio with one *nexoDAQ* node, showing data and FFTs from three sensors



3.1.1 Toolbar and Menu

The toolbar is used to quickly access the most used functionality of Inertia Studio. This section describes the default buttons of the toolbar, from left to right (see Figure 21).

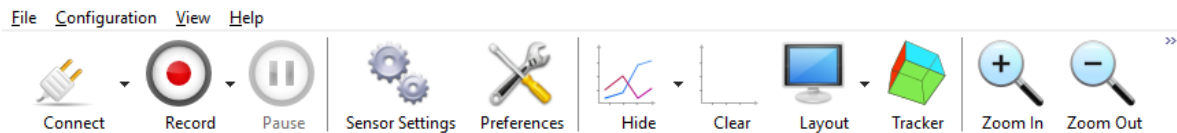

Figure 21: Inertia Studio menu and toolbar

- **Connect / Disconnect**

The *Connect / Disconnect* button can be used to quickly connect to, or disconnect from an Inertia device. The drop-down menu associated with this button opens a list for selecting the target device. See Section 3.2 for more information.

- **Record / Stop**

When connected to a device, the *Record / Stop* button can be used to quickly start and stop logging/recording to file (see Section 3.3). If timed recording is enabled, a small clock overlay is shown on the icon. The drop-down menu associated with this button offers rapid access to the *Logging Configuration* window (see Section 3.3). The user can also quickly set the duration of the recording using time-presets.

- **Pause / Resume**

The *Pause / Resume* button is enabled when replaying a logfile. It can be used to pause and resume the replay.

- **Sensor Settings**

The *Sensor Settings* button opens the *Sensor Settings* window (see Section 3.8).

- **Preferences**

The *Preferences* button opens the *Preferences* window (see paragraph 3.12.2.2).

- **Hide / Show**

The *Hide / Show* button toggles between hiding and showing the data in the plots. The drop-down menu associated with this button opens a list for selecting the target device for which the data is hidden or shown. An small sign (i.e. red cross or yellow triangle) on the icon indicates that some data is hidden. This button does not influence the logging.

- **Clear (F5)**

The *Clear* button, or F5, clears the plots, legend and device lists. This button does not influence the logging.

- **Layout**

The *Layout* button opens the *Layout Wizard* (see Section 3.12.1) and has a drop-down menu to switch between layouts.



- **Tracker**

The *Tracker* button opens the *Tracker* window (see Section 3.10).

- **Zoom In (F3) / Zoom out (F4)**

The *Zoom* buttons, or F3 and F4, can be used to zoom the X-Axis of all plots in or out.

The menu allows access to all the options of Inertia Studio and has the following items:

- **File**

—*Connect* opens the *Connection Configuration* window (Section 3.2).

—*Record* opens the *Log to File* (Section 3.3) and *Log to Flash* (Section 3.4.1) windows.

—*Replay* opens the *Replay* window (Section 3.7).

—*Download* opens the *Download Logfiles* window (Section 3.4.2).

—*Fill-in Lost Samples* opens the *Fill Loss* window (Section 3.5).

—*Export* opens the *Export Logfiles* window (Section 3.6).

—*Exit* closes Inertia Studio.

- **Configuration**

—*Sensor Settings* opens the *Sensor Settings* window (Section 3.8).

—*I/O Settings* opens the *I/O Settings* window (Section 3.9).

—*Sensor Calibration* opens the *Calibration Configuration* window. This setting is not applicable to *nexoDAQ*.

—*Preferences* opens the *Preferences* window (paragraph 3.12.2.1).

—*File Types* opens a sub-menu to configure the supported file types.

—*Power Down* allows the user to remotely power down specific devices.

- **View**

—*Layout Wizard* opens the *Layout Wizard* (Section 3.12.1).

—*Tracker* opens the *Tracker* window (Section 3.10).

—*Detailed Status* opens the *Detailed Status* window (paragraph 3.1.3.4).

—*Toolbox* can be used to show or hide the *Zoom and Pan* sliders and the *Log and Legend* in the information area.

—*Toolbar* can be used to change the appearance of the toolbar. The toolbar can be hidden using the *Hide* option. The size of the toolbar icons can be modified to *Small*, *Medium* and *Large*. *Show Text* allows to show or hide the text below the icons. *Show I/O Buttons* adds two extra buttons to the toolbar for I/O functionality.

—*Show Data* toggles between showing and hiding the incoming data in the plots.

—*Clear Plots (F5)* clears the plots, legend and device lists.

—*Full Screen (F11)* shows Inertia Studio in full-screen mode.

- **Help**

—*Check for Updates* checks if a new version of Inertia Studio is available, or if new firmware for the connected nodes is available.

—*Firmware Update* opens the *Firmware Update* window (Section 3.13).



- Software Web Site* opens the Inertia Technology software website.
- Manual (F1)* opens the Inertia Studio manual.
- About* shows the current Inertia Studio version and build date.

3.1.2 Plots

Inertia Studio can be configured to display a customizable number of plots that show in real-time the sensor data, status data (e.g. battery voltage, lost samples) and processed data (e.g. FFT). The shown plots and layout can be customized via the Layout Wizard (see Section 3.12.1). The X-axis of the time-plots represents the number of seconds since the gateway was started.

The mouse can be used to zoom and pan the plot. Holding the left mouse button while moving the mouse creates a zoom-box. Releasing the left mouse button zooms to the selected data. Note that *Auto-scaling* resets the Y-axis zoom. A plot can be panned by holding the right mouse button and moving the mouse. By default, the X-axis is automatically set to the latest received data. Disable *Show Data* or use the pan slider (see Section 3.1.3) to prevent this.

Right-clicking on a plot provides the following options (see Figure 22):

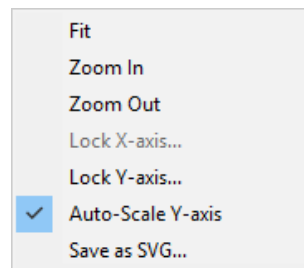

Figure 22: Plot right-click pop-up menu

- **Fit:** Fits all received data in the plot.
- **Zoom in/out:** Zooms the plot in or out. The *Zoom* buttons in the toolbar and the *Auto-scaling* option (see paragraph 3.12.2.2) can be used to reset the zoom.
- **Lock X-axis...:** Locks the X-axis to a specified range by showing a pop-up window in which the minimum and/or maximum values of the X-axis can be set. When the axis is locked, a ← and/or → symbol is shown at the bottom right and/or left corner of the plot. This option is only enabled for FFT plots.
- **Lock Y-axis...:** Locks the Y-axis to a specified range by showing a pop-up window in which the minimum and/or maximum values of the Y-axis can be set. When the axis is locked, a ↑ and/or ↓ symbol is shown at the left top and/or bottom corner of the plot. Locked plots do not auto-scale.
- **Auto-Scale Y-axis:** Toggle automatically scaling the Y-axis. This overrules the global auto-scaling option in paragraph 3.12.2.2.
- **Save as SVG...:** Save the plot as a SVG image.



3.1.3 Information Area

The information area at the bottom of the main screen shows the list of event messages and the legend with connected device. In addition, a zoom-slider, a pan-slider and buttons to set and get the time of the devices can be added to the information area via the menu (*View, Toolbox*).

3.1.3.1 Notification Area

Event notifications are displayed in the notification area. They give information about the outcome of certain actions, such as plugged-in or removed devices, connecting to or disconnecting from a device, starting or stopping logging, downloading or exporting files, modifying sensor configurations, etc. By clicking the header of the time column, the notifications can be sorted in ascending or descending time order. Right clicking an item in the list provides the following options: copy the selected line(s), copy all lines, and clear the notification area.

The icon in front of a message indicates the notification type. A green check-mark means success, a red cross means error, an orange triangle means warning and a blue circle means information.

3.1.3.2 Legend

The legend contains a list of all the devices of which sample data is received. The first column shows the line colour and ID for each device. The *NodeID* can be extended with a name in paragraph 3.12.2.3. The second column (*Signal*) displays the radio signal strength (when connected via a gateway), or the transmission type (when connected via USB). The third column (*Battery*) shows the battery level for each device, and whether the device is charging. The fourth column (*Loss*) shows the percentage of lost samples over the last period (see also paragraph 3.12.2.1). The fifth column (*Flash*) shows whether the device is logging to flash or not. The legend can be sorted on every column. Columns can be hidden by right-clicking the column header. Double-clicking on the legend opens the *Detailed Status* window (see paragraph 3.1.3.4).

The radio strength is updated every second. The battery level is, by default, updated every ten seconds. The loss update interval can be configured via the global preferences (see paragraph 3.12.2.1).

3.1.3.3 Zoom and Pan

The *zoom* and *pan* sliders can be used to change the visible data in the plots. The *zoom* slider behaves the same as the zoom buttons in the toolbar (Section 3.1.1) and allows to zoom the X-axis in or out. The *pan* slider allows the move back in time and show older data. The maximum number of seconds to pan can be configured in the global settings (*Plot History* in paragraph 3.12.2.1). If panning is active, plots are not updated with new sample data.

3.1.3.4 Detailed Status

The *Detailed Status Overview* window (see Figure 23) can be accessed by double clicking an item in the legend or via the *View* menu, sub-menu *Detailed Status*. The window shows de-



tailed information about the battery level, CPU temperature, external input, RSSI and sample loss of the connected devices. The plots are cleared when (re)connecting to a device or when using the *Clear* button.



Figure 23: Detailed Status information

The battery, temperature and external input plots are updated when status information from a device is received via automatic status messages (usually every ten seconds). The RSSI plot is updated every second with the average value of the received RSSI information. The sample loss plot is updated every second with the detected sample loss. The time on the X-axis is the system time.

A checkbox is available to disable automatic updating of the plots. This can be used to prevent the plots from resetting when zoomed in. The *Send Request* button broadcasts a message to all devices with a request to send the current battery and CPU temperature value. The *Plots* button can be used to show or hide specific plots.



3.2 Connecting to a Device

In this section we describe how an Inertia device can be connected to the PC, using the following connections:

- **USB:** Any Inertia device can be connected to the PC using USB. The mini-USB connector of the gateway and the micro-USB connector of *nexoDAQ* can be used for direct connection to the PC using a USB cable.
- **Ethernet:** The Advanced Inertia Gateway can also be connected using Ethernet to the PC. The gateway can be connected either directly to the network adapter of the PC using an Ethernet cable, or indirectly using an Ethernet cable to a (wireless) switch or router that is in the same local network as the PC. Inertia Studio requires Npcap or WinPcap on Windows and libpcap on Linux and macOS to access the network adapter and receive the Raw Ethernet data.

The connection can be started via the *Connect* button in the toolbar or from the *File* menu item, option *Connect*.

3.2.1 Connecting to a Device Using the Toolbar

Pressing the arrow next to the *Connect* button in the toolbar opens the drop-down menu shown in Figure 24:

- The option *Connect...* opens the *Connection Configuration* window, which is explained in Section 3.2.2.
- The option *Available...* opens a pop-up window with all the available devices, including the active network adapters. A setting in the *Global Preferences* (Section 3.8.1) can hide the network adapters from the list of available devices.
- Below the line, a list is shown with the names of the available Inertia devices connected through USB and the active network adapters, i.e. the local and/or the wireless network adapters. Next to them, the corresponding port numbers are given. A • symbol in front of the name indicates the device is selected. A ► symbol in front of the name indicates the device is connected.

Select the desired device and press the *Connect* button in the toolbar to connect.

3.2.2 Connecting to a Device Using the Menu

The option *Connect* from the *File* menu item opens the *Connection Configuration* window from Figure 25. The window shows a list with *Stored Configurations*, i.e. all the connections to Inertia devices that were previously used and those that are currently available. The list includes the devices connected through USB and the active network connections, e.g. the local and/or the wireless network connections. The port name (“com*” on Windows and “/dev/*” on Linux)

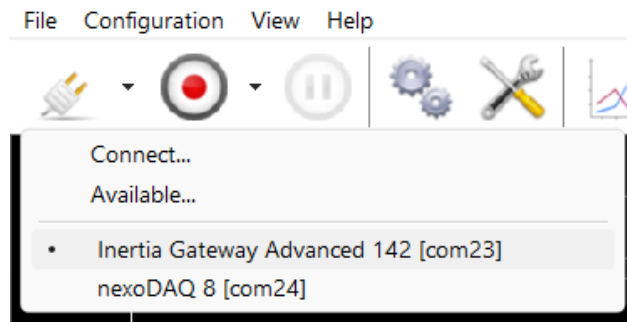

Figure 24: Connect drop-down menu

is shown next to the device name. A green dot indicates the device is available. The ► symbol indicates the device is connected.

By pressing the *Available?* button, the list is updated and a pop-up window with all the available devices is shown. The *Show* button loads the selected connection into the main screen. The *Add...* button can be used to manually add a device to the list if it is not automatically detected. The *Remove* button removes a selected device from the list. The *Connect/Disconnect* button starts and shows, or stops, the selected connection with the device.

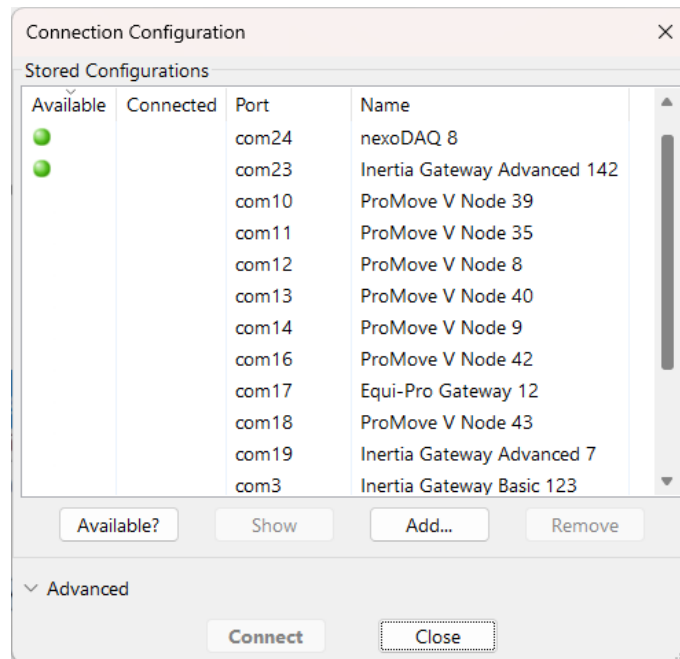

Figure 25: Connection Configuration



3.3 Logging to File

When connected to an Inertia device, the incoming data can be stored/recorded in a log file. The default file format is *itlog* (Inertia Log File). Incoming samples, node information and configurations, etc, are stored in the file. An *itlog* file can be exported to a different format (see Section 3.6).

There are two options that can be used to enable logging to file:

1. By using the *Record* button from the toolbar; to change the settings for creating a log file, select the *Log to File...* option from the drop-down menu of the *Record* button; this option opens the *Logging Configuration* window for logging to file (see Figure 26).
2. By selecting the *Log to File...* option from the *File* menu, *Record* item; this option opens the same *Logging Configuration* window for logging to file (see Figure 26).

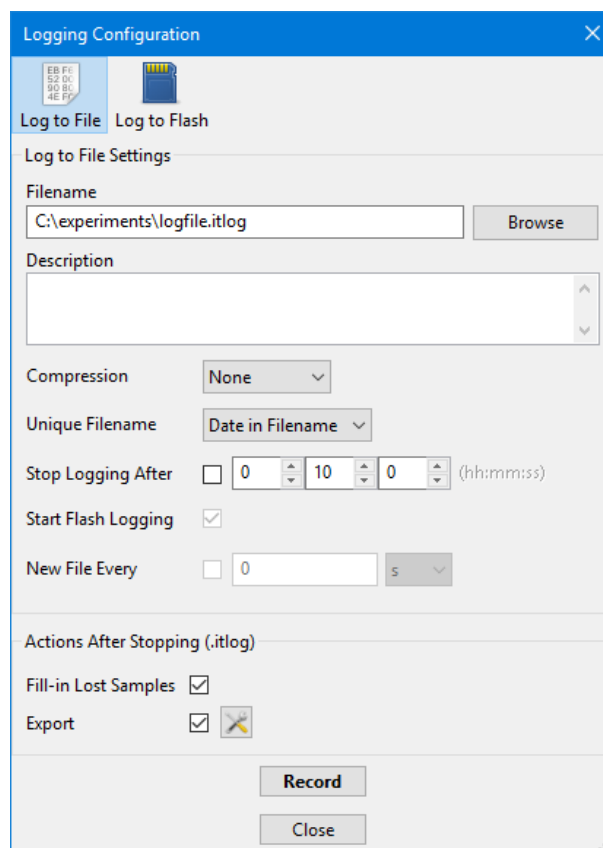

Figure 26: Log to File Configuration

In the *Logging Configuration* window, the settings for creating a log file can be modified as follows:

- **Filename:** The name of the log file. The default file format is *itlog*.
- **Description:** A description that can be added to the beginning of the (exported) log file.



- **Compression:** An optional compression format used for the log file, resulting in a smaller file size. Supported compression methods are: **gzip** (.gz, GNU Zipped Archive), **bzip** (.bz2, BZIP2 Compressed Archive) and **zlib** (.Z, UNIX Compressed Archive).
- **Unique Filename:** Selects the way of handling existing log files with the same name:
 - **Overwrite:** The existing file is overwritten.
 - **Auto-Number:** Files are numbered in sequence with the following naming convention: *<filename>[_No].ext*, where *ext* is the file extension and *No* is the sequence number; this number is automatically increased every time a log file with the same name is created.
 - **Date in Filename:** The current local or UTC date and time are added to the filename; the timestamp is formatted as described in ISO 8601 (i.e. *[YYYYMMDDThhmmss_]<filename>.ext*).
- **Stop Logging After:** This option can be enabled to automatically stop logging to file. The duration can be entered as *hh:mm:ss*. When active, a countdown is shown in the toolbar.
- **Start Flash Logging:** Starts (and stops) logging to flash when a log file is created. This option is enabled by default when *Fill-in Lost Samples* is enabled.
- **New File Every:** Start logging to a new file once the provided number of seconds or file size is reached. *Fill-in Lost Samples* and *Export* should be disabled.
- **Fill-in Lost Samples:** Fills-in lost samples when logging to file is finished (see Section 3.5).
- **Export:** Exports the log file when logging to file (including filling in lost samples) is finished. The button opens the Section 3.6 window.

If a device is connected, the *Record* button can be used to save the settings and start creating a log file. If the device is disconnected, the *Save* button can be used to save the current settings. The *Stop* button can be used to stop logging. These buttons behave similarly to the *Record / Stop* button in the toolbar, described in Section 3.1.1.



3.4 Logging to Flash

nexoDAQ nodes have an internal flash memory that can be used to store sensor data. Flash logs can be created manually, as described in Section 3.4.1. Section 3.4.2 describes the way the flash logs can be downloaded to the PC.

3.4.1 Starting and Stopping a Flash Log

The *Log to Flash* option from the *File* menu, *Record* item, opens the *Logging Configuration* window for logging to flash (see Figure 27).

The *Logging Configuration* window shows the list of all devices in the network. For each node in the list, the ► symbol indicates whether the node is logging to flash or not. If a timer is used when starting the flash log (the *Stop Logging After* option is enabled), a countdown is visible in the list. The last column in the list shows the sensor data types that are logged to flash (see Section 3.8 to enable or disable sensors).

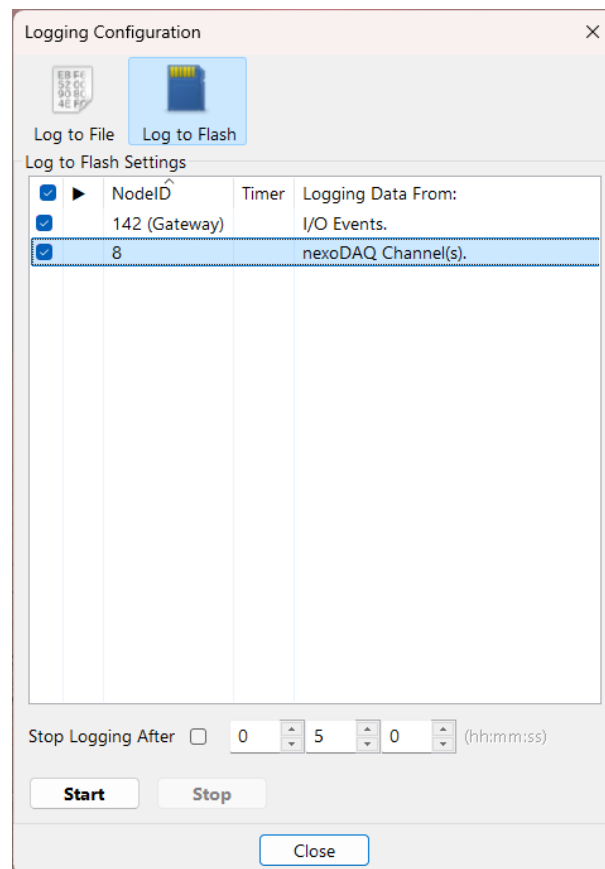

Figure 27: Log to Flash Configuration

The *Start* / *Stop* buttons can be used to send a command to the checked node(s) to start or stop logging to flash. The *Stop Logging After* option activates a timer for stopping the flash logging. Closing Inertia Studio while a timer is active does not determine a node to stop logging to flash. The format of the timer is *hh:mm:ss*.



When starting or stopping a flash log, a notification message appears in the information area at the bottom of the main screen with the response from the node, indicating success or failure. A failure can occur when logging to flash is already started (or stopped).

Flash logs are named *LOG<No>.LOG*, where *No* is the first available number starting from 1. The creation date of the flash log is also recorded. The date is based on the internal clock of the node. If the battery of a node is fully drained, the clock is reset, which can result in an incorrect creation date. The internal clock is automatically synchronized with the PC time when data from a node is received by Inertia Studio.

3.4.2 Downloading a Flash Log

Downloading a flash log can be done either wirelessly or through a USB cable, which is much faster. By selecting the *Download* option from the *File* menu, the *Download Flash Logs* window appears, as shown in Figure 28. When a node is selected in the drop-down list, status information about the internal flash is shown, and the *File list* is updated with the flash logs present on the internal flash of the node. The filename, file-size and creation date (local time) of each file is shown in the list. By selecting a node or using the *Refresh* button on the right hand side, the status information and file-list are updated. Active files (e.g. files currently being created) are not included in the file list.

To download a file, select it in the *File list* and adjust the following options:

- **Destination:** The name of the file (*itlog* format). Several wildcards are supported in the filename:
 - **{name} or %s:** Insert the full flash file name (without extension).
 - **{no} or %d:** Insert the number of the flash file (e.g. 34 for LOG34.LOG).
 - **{date} or %c:** Insert the creation date of the flash file (in ISO 8601 format).
 - **{id} or %i:** Insert the node ID.
- **Unique Filename:** Selects the way of handling existing log files with the same name (same as in Section 3.3).
- **Use Date from Flash File:** Set the creation date of the file to the date of the flash file.
- **Export:** Export the file when downloading is finished. Use the button to open the Export Settings. (see Section 3.6).

Press *Download* to start the download. If the node is transmitting data, transmission will be temporarily disabled until the download is finished.

During downloading, the progress is shown in the list. Information about the progress is also shown in the information area at the bottom of the main screen (see paragraph 3.1.3.1). When downloading is in progress, the *Cancel* button can be used to cancel the process. If a file is being



downloaded, other files of the node can be queued so they will start downloading as soon as the current file is finished. Select one or more **LOG*.LOG** files, adjust the file options, and press *Queue*.

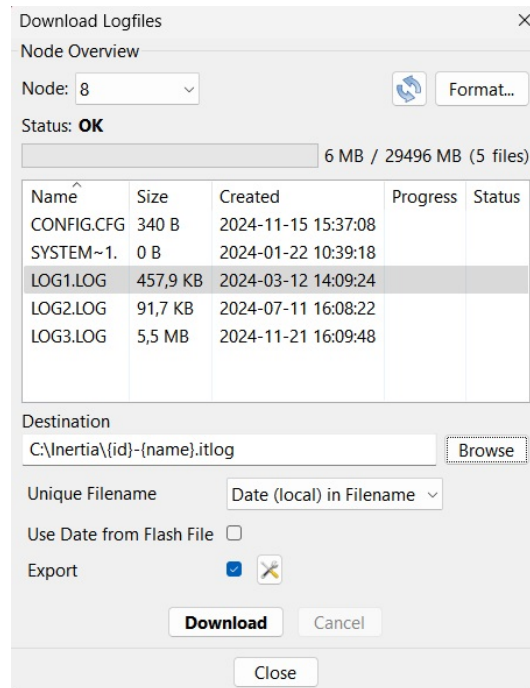

Figure 28: Download Flash Logs

3.4.3 Deleting Flash Logs

Flash logs can be removed from the flash memory using the *Format* button in the *Download Logfiles* window (Figure 28). This action removes all files from the internal flash memory. Formatting takes about 5 to 10 seconds. A message is shown when formatting is finished.

Do not turn the nodes off during formatting!



3.5 Filling in Lost Samples

When performing an experiment with wireless sensor nodes, there is almost always some data loss. This loss can be filled in automatically after the experiment is finished. This feature is available only for experiments performed with a gateway, when the sensor nodes are in *Synchronous* mode (see Section 3.8.1 for details about sampling mode). If the sensor nodes are in *Stand alone* mode, or if the sensor nodes are connected using a USB cable this feature is not available.

The sections below explain this process of filling in the lost samples.

3.5.1 Automatic

Enable *Fill-in Lost Samples* when creating a logfile (see Section 3.3). Once logging is stopped, a pop-up is shown informing that missing data will be filled in. Once continued, the *Fill-in Lost Samples* window is shown (Figure 29) and missing data is automatically filled in.

The process consists of three stages:

1. First, the existing logfile is analyzed and missing data of each node is identified. During this stage, a progress bar for each node is filled with blue bars. The tint of the color represents the amount of lost data: white is 100% loss, dark blue is 0% loss. The percentage inside the progress bar is the total percentage of samples available.
2. During the second stage, the missing data is requested wirelessly from the nodes (Figure 29). The progress bars are actively being updated to reflect the received data. The lighter segments change to dark-blue.
3. In the third stage, the received data is merged into the *itlog* file (Figure 30). The progress bars are filled with green bars to show the progress. If there is still some missing data, sections in a progress bar are made red and messages with information about the missing sections are added to the notification area. A manual restart could fill in the remaining missing samples (see Section 3.5.2).

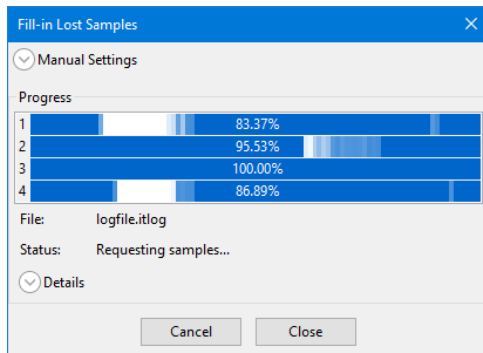

Figure 29: Requesting

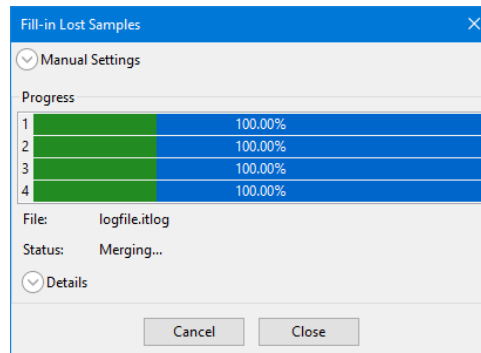

Figure 30: Merging

Once the process is finished, and if *Export* was enabled when the logfile was created, the file



is exported in the background. If the fill-loss process is canceled using the *Cancel* button, a pop-up asking to continue with export is shown.

3.5.2 Manual

Filling in lost samples can also be started manually. Open the window via the menu (*File, Fill-in Lost Samples*) and expand the manual settings using the *Manual Settings* arrow (Figure 31). Provide the following parameters:

- **File(s):** One or more *itlog* files to be filled in.
- **Port:** The port used to access the node(s), usually the port of the gateway.
- **Export:** Export the *itlog* file when filling in lost samples is finished or canceled. Use the button to open the Export Settings. (see Section 3.6).
- **Backup:** Keep a backup of the unfilled file (named *<filename>_BACKUP_.itlog*).
- **Slots:** Temporarily change the number of slots (to a lower value) to increase the fill-loss speed. This should be equal or higher than the number of devices in the network. Leave empty or use *0* for the default number of slots.
- **Flash Diff (S):** The maximum time difference in seconds between the creation date of the pc file and the node's flash file.

Press *Start* to start the process.

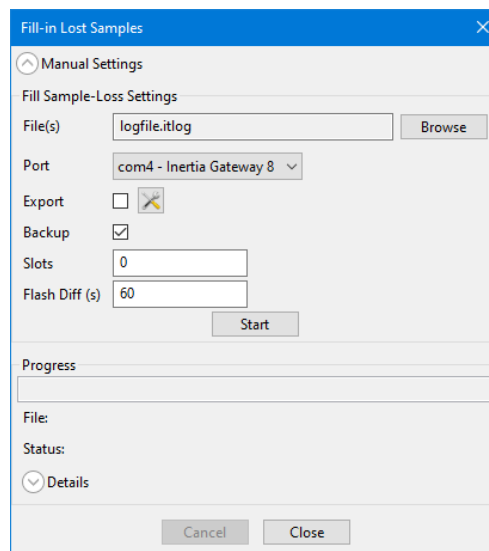

Figure 31: Manual settings

The *Details* arrow expands the window and shows a list with all status messages. The messages can be copied or cleared using the *Copy* and *Clear* buttons. The *Auto-scroll* checkbox enables or disables automatic scrolling to the latest message.



3.6 Exporting a Logfile

Inertia Log Files of type *itlog* can be exported to different file types using the *Export Logfiles* window (see Figure 32), which can be accessed from the menu (*File, Export*). The following parameters can be modified:

- **Format:** The file format to export the *itlog* file to (Figure 33). Settings specific to the file format can be modified via the *Configure* button (see the next sections for available options).
- **Compression:** An optional compression format used for the exported file, resulting in a smaller file size. Supported compression methods are: **gzip** (.gz, GNU Zipped Archive), **bzip** (.bz2, BZIP2 Compressed Archive) and **zlib** (.Z, UNIX Compressed Archive).
- **Unique Filename:** Selects the way of handling existing log files with the same name (same as in Section 3.3).
- **Source(s):** The *itlog* file(s) to export or merge. The *Destination* filename is automatically updated to match the source name and the selected file format.

Use the *Start* button to save the settings and export the file(s). Active and previously exported files are shown in the *Activity List*. Double-clicking an item opens the exported file in its default program. An active item can be canceled using the *Cancel* button. Previously exported files in the activity list can be cleared using the *Clear* button. The folder of a selected item can be opened using the *Open Folder* button.

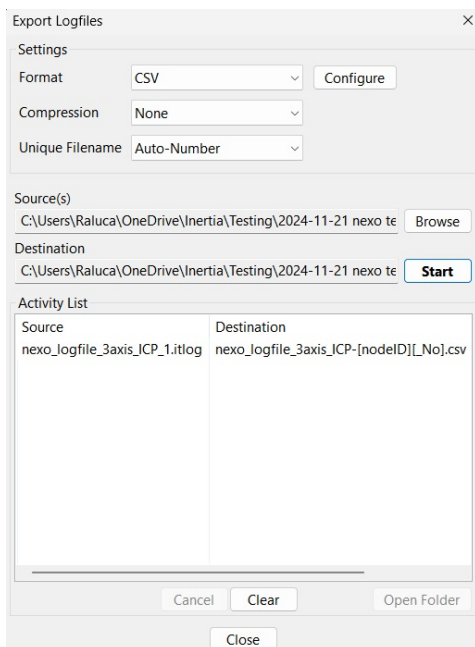

Figure 32: Export logfiles

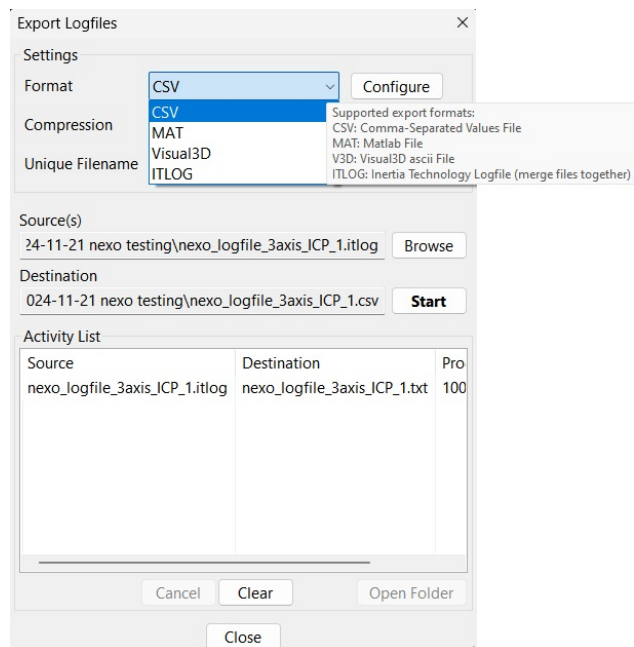

Figure 33: File format options



3.6.1 CSV Settings

Inertia Log Files can be exported to a Comma Separated Values file (CSV). The CSV Settings can be modified in the *CSV Settings* window (see Figure 34), accessible via the menu (*Configuration, File Types, CSV Settings*) or from the *Export* window.

A CSV file starts with a header identifying each column. Each subsequent line in the CSV file consists of a timestamp and the sensor data sampled at that timestamp.

The following settings can be modified for the CSV file format:

- **One File per Node:** A separate file is created for each node; the node number is appended to the filename: `<filename>[_nodeNo].ext`. When disabled, one file with data from all nodes is created.
- **Repeat Previous Value:** When sensors have a lower sampling rate than the global sampling rate, empty values are added to the CSV file (no value between commas). . By using this option, instead of logging an empty value, the last received value is repeated until a new value is received.
- **Add Info to Beginning of File:** Add information such as node information, sensor settings, units of measurement, a description, etc, to the beginning of the log file. The information lines start with a #.

The sensor data added to the CSV file can be configured by (un)checking the desired *Columns*. For *nexoDAQ*, the data is made available in the logfile by selecting the **ADC** option. The *Apply* button saves the settings and closes the window. The *Close* button discards any modified settings and closes the window.

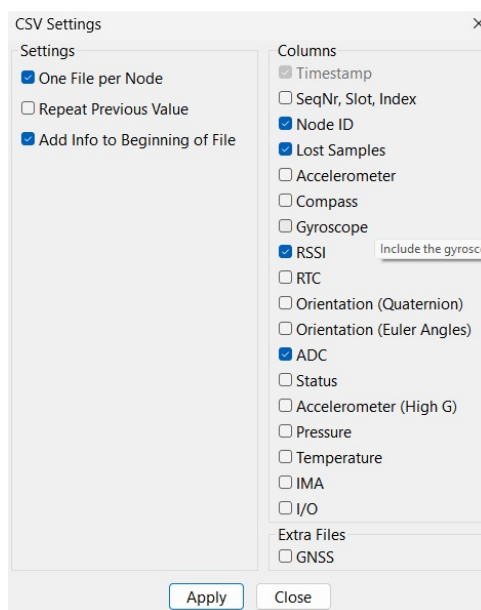

Figure 34: CSV Settings



3.6.2 MAT Settings

Inertia Log Files can be exported to a MatLab MAT file. The MAT Settings can be modified in the *MAT Settings* window (see Figure 35), accessible via the menu (*Configuration, File Types, MAT Settings*) or from the *Export* window.

The MAT file contains a global structure array with a field for each node structure. Each node structure contains four fields. Field *columns* contains the column names and indices of the columns, *fields* combines multiple columns into one field (e.g. *ax*, *ay* and *ax* into accelerometer), *data* contains the sensor data, and *samplingRate* contains the sampling rate.

The following settings can be modified for the MAT file format:

- **Struct Name:** The name of the global structure array.
- **MAT Version:** The MAT-file version (see MatLab documentation).
- **MAT Compression:** Enable compression of the MAT file.
- **No. of Samples:** The number of samples in the MAT file. This option is not relevant when exporting an *itlog* file to MAT. Only when logging directly to a MAT file, the number of samples to store needs to be known beforehand. If more (or less) samples are logged, these are ignored (or filled with NaN).

The sensor data added to the MAT file can be configured by (un)checking the desired *Columns*. For *nexoDAQ*, the data is made available in the logfile by selecting the **ADC** option. The *Apply* button saves the settings and closes the window. The *Close* button discards any modified settings and closes the window.

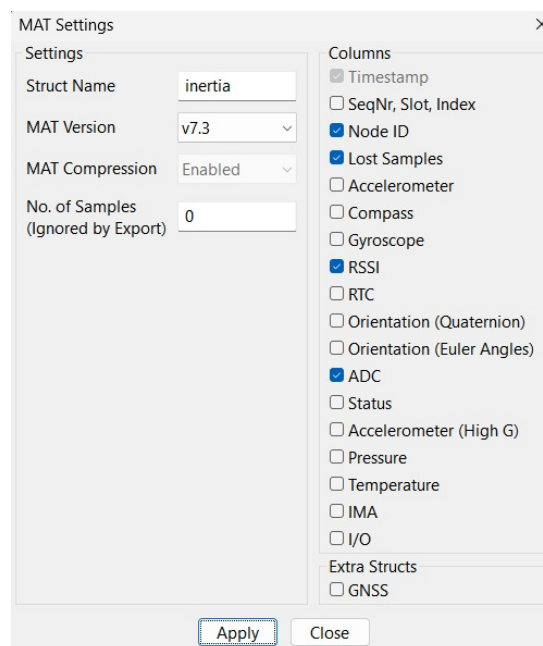

Figure 35: MAT Settings



3.6.3 Visual3D Settings

The Visual3D Settings are not applicable to data acquired with a *nexoDAQ* device.

3.6.4 ITLOG Settings

Inertia Log Files can be merged or rewritten. The ITLOG Settings can be modified in the *ITLOG Settings* window (see Figure 36), accessible via the menu (*Configuration, File Types, ITLOG Settings*) or from the *Export* window.

When multiple *itlog* files are selected in the export window, these will be merged together into one file. When one *itlog* file is selected, it will be parsed and rewritten.

By default, the source info of the new itlog file will be the same as the (first) source file. The source info can be changed by enabling the **Enable Replacing Source Info** checkbox. Use the **Load Info From Source File** button to fill the fields with the source info of the (first) source file.

The following fields can be modified:

- **Created Date:** Unix timestamp when the file was created (required).
- **Version Info:** Information about the application that created the file.
- **Original Filename:** The original name of the file, for example when the file was downloaded from the flash memory of a sensor node.
- **Description:** Extra information that was provided when creating the file (see Section 3.3).

The *Apply* button saves the settings and closes the window. The *Close* button discards any modified settings and closes the window.

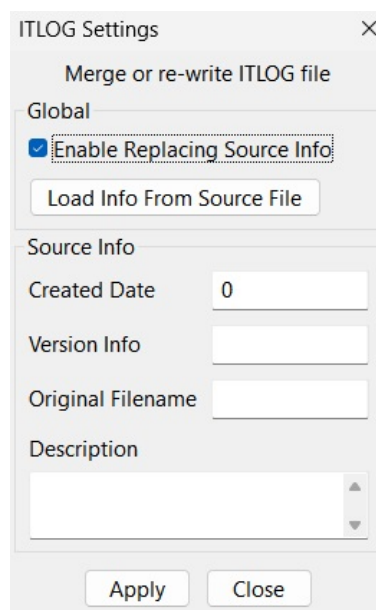

Figure 36: ITLOG Settings



3.7 Replaying a Logfile

The *Replay Logfile* window can be used to replay a previously created logfile in real-time, or analyze and plot an entire logfile.

3.7.1 Real-Time

Real-time replay has the following options:

- **Logfile:** The logfile to be replayed.
- **Hardware Type:** (CSV only) The hardware type of the device used in the logfile. This is necessary to determine to correct initial orientation in the tracker.
- **Rewrite Replay:** (CSV only) The logfile will be rewritten to a new file (same name, with *-replay* appended), and the orientation (Euler angles and/or quaternions) will be re-calculated.
- **Sampling Rate:** The sampling rate used in the logfile. Used to calculate the *Read Interval*.
- **Number of Nodes:** The number of nodes in the logfile. This is used to calculate the *Read Interval*.
- **Read Interval:** The number of samples to read per second. The initial value is determined by the *Sampling Rate* and *Number of Nodes*, but the interval can be manually adjusted. During a replay, the slider can be used the change the speed of the replay.

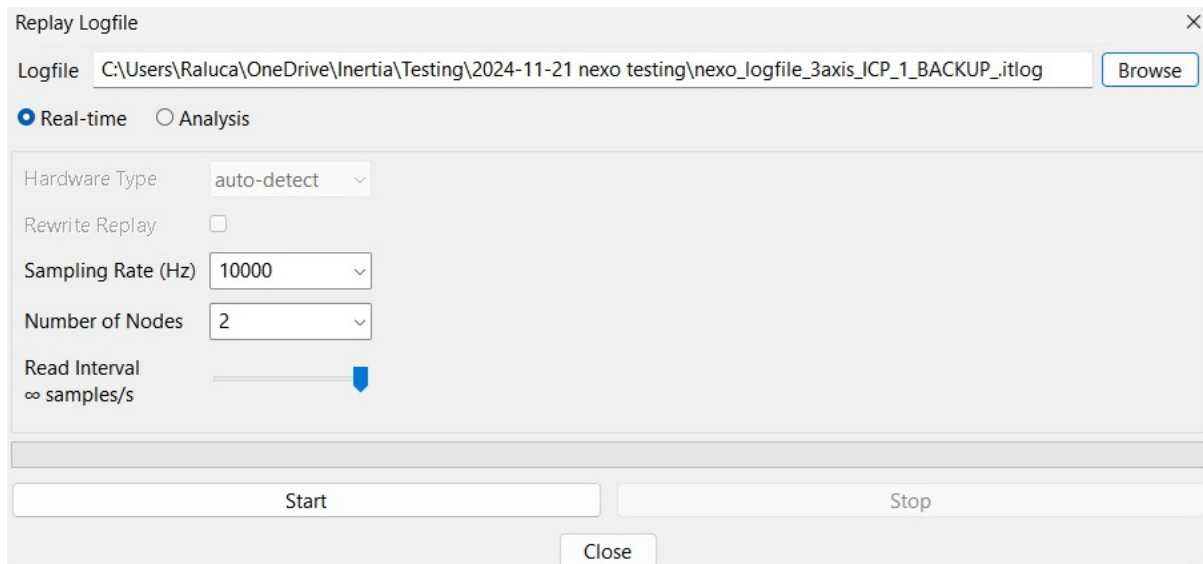

Figure 37: Replay Logfile window

A replay is started with the *Start* button, and stopped with the *Stop* button. During the replay, it can be paused with the *Pause* button. The buttons in the toolbar can also be used to control



the replay. Replays are added to the drop-down menu of the *Connect* button. Finished replays are removed from the drop-down menu when the *Available...* option is used.

Figure 38 shows the Inertia Studio main window while replaying a logfile.

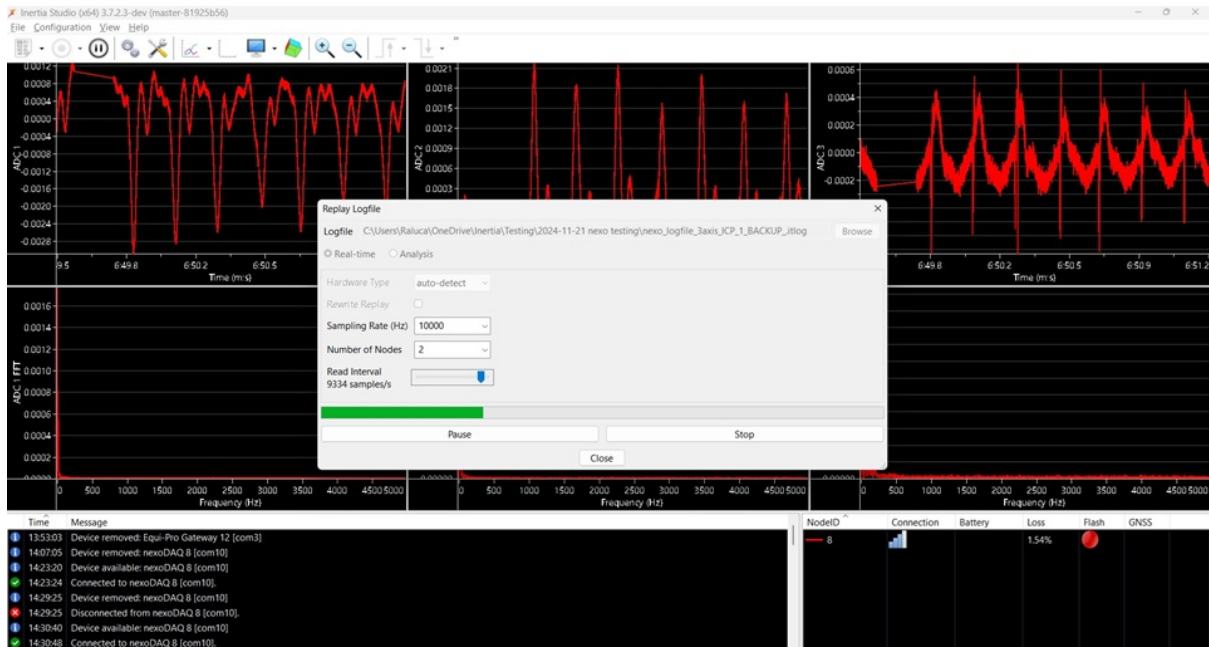

Figure 38: Replaying a logfile

3.7.2 Analysis

Replay analysis can be used to analyze a logfile and detect timestamp issues. It detects *Rollbacks* (timestamp is lower than the previous timestamp), for example when the sampling rate is changed during the experiment. *Duplicate Timestamps* are detected when subsequent timestamps are the same. *Gaps* are detected when samples are lost.

It has the following options:

- **Logfile:** The logfile to be analyzed.
- **Rollbacks:** Detect and show timestamp rollbacks in the log.
- **Duplicate Timestamps:** Detect and show duplicate timestamps in the log.
- **Gaps:** Detect and show timestamp gaps in the log.
- **Show Sample Data in Plots:** Collect all the sample data and show them in the plots once analysis is finished. For large logfiles, this requires a lot of memory.

Analysis is started with the *Start* button, and stopped with the *Stop* button. During the analysis, it can be paused with the *Pause* button. Once the analysis is finished the data of the logfile is shown in the plots. When the plot layout is changed, *Reload Plot* can be used to recreate the plots. *Clear Results* will clear the log and remove the collected sample data from memory.

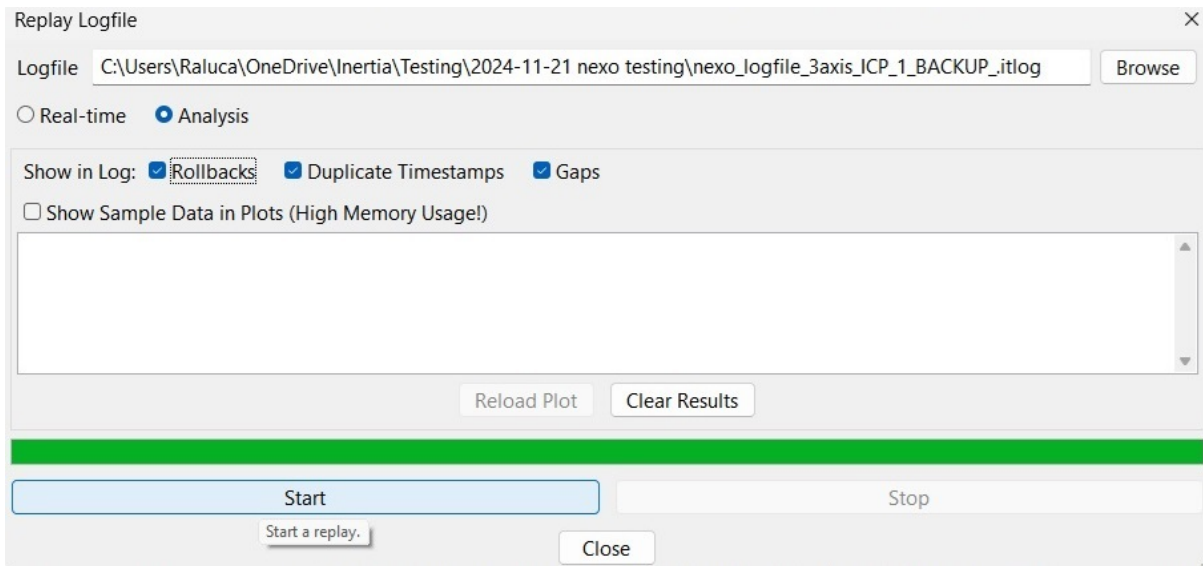

Figure 39: Replay Logfile

Figure 40 shows the result of the analysis performed on the given logfile. The analysis identifies the gaps in the acquired data, giving an overview about the number of lost samples, total number samples, rollbacks, duplicates, gaps, sampling rate and log duration.

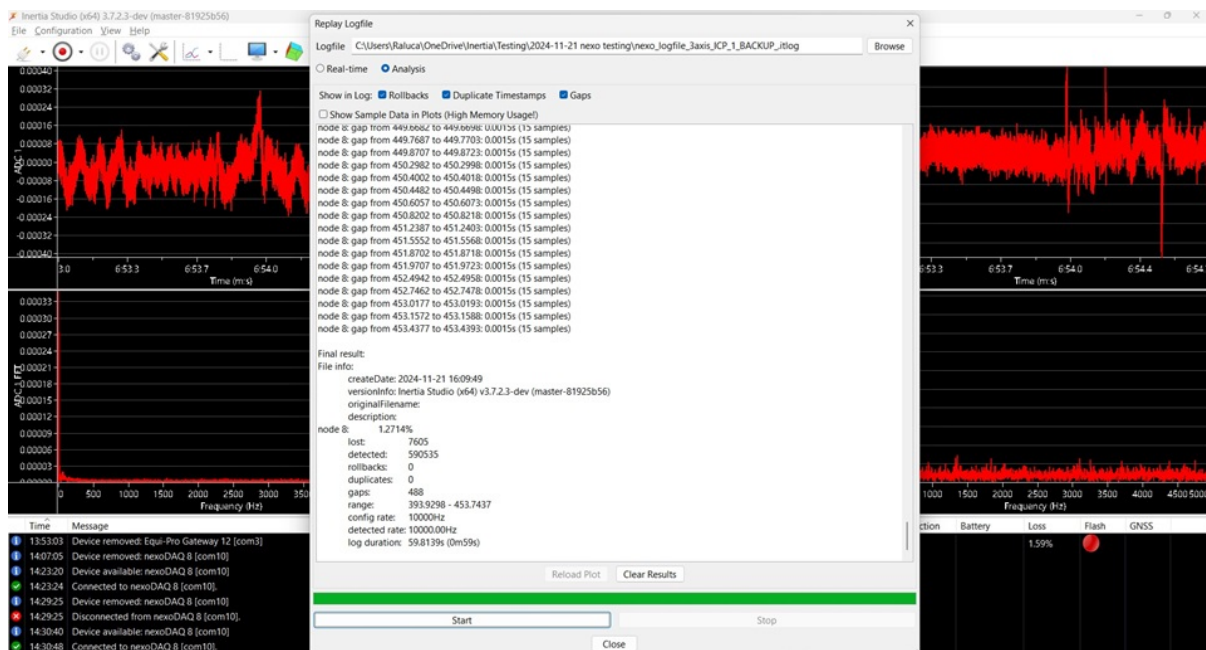

Figure 40: Replaying a logfile



3.8 Configuring the Sensors

The *Sensor Settings* window can be used to modify the configuration of Inertia nodes. This window is accessible via the toolbar and via the *Configuration* menu, item *Sensor Settings*. Once a device is connected, the configuration options of the detected Inertia nodes is shown in this window.

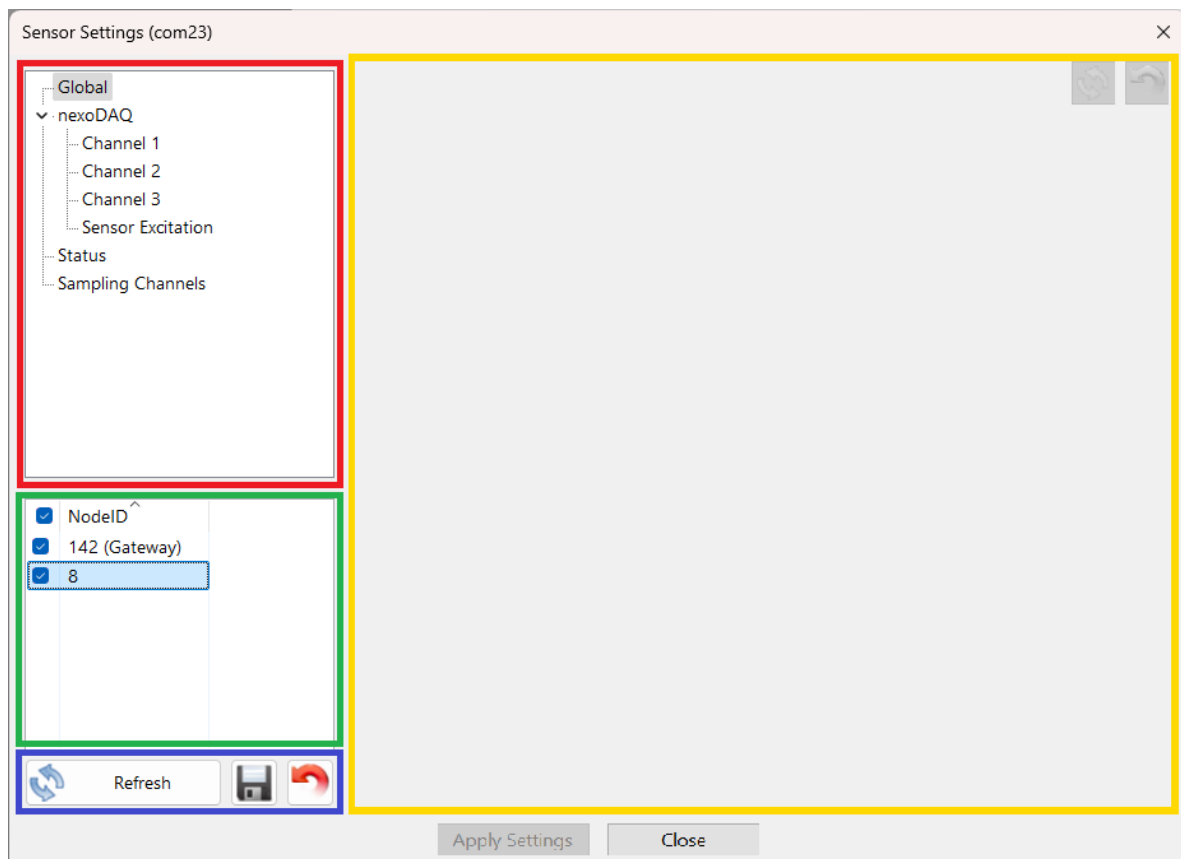

Figure 41: Sensor Settings

Figure 41 shows the *Sensor Settings* window, which is divided in the following areas:

- *The node list area*, marked with **green** in Figure 41, contains the list of devices available via the currently selected connection. When a node is *selected*, its configuration options are shown in the sensor tree. When a node is *checked* by using the checkbox beside it, the actions of the buttons refer to this node. In Figure 41, all nodes are checked, so the configuration is applied to all these nodes after pressing the *Apply Settings* button.
- *The sensor tree*, marked with **red** in Figure 41, shows the available configuration options of the selected nodes in the node list. When choosing an option in the tree, the corresponding configuration settings are shown in the settings panel. The different configuration options in the sensor tree are discussed in the subsequent sections.
- *The buttons*, marked with **blue** in Figure 41, have the following functions:



- **Refresh** This button can be used to request *all* the configurations from *all* nodes. The purpose is to make sure that configurations are successfully applied and correctly retrieved by Inertia Studio.
- **Store** This button stores the current configuration of the *checked* nodes in their flash memory, so the settings are retained when the nodes are turned off. The button is *not visible* if configurations are automatically stored (paragraph 3.12.2.1).
- **Restore** This button can be used to restore *all* the configurations of the *checked* nodes. The nodes are reset to their factory-default settings.
- **Apply Settings** This button applies all the modified settings (shown bold in the sensor tree) to the *checked* nodes in the list. If no settings are modified, the currently shown settings are applied. If settings are stored automatically, a 15 second countdown is shown.
- **Close** This button closes the window, discarding all modified settings.
- *The settings panel*, marked with **yellow** in Figure 41, shows the settings available for the selected configuration option of the selected node in the node list. These settings are discussed in detail in the subsequent sections. When invalid or not recommended settings are used, these settings are marked with a red (invalid) or orange (not recommended) colour. Invalid settings cannot be applied. Error, warning and information messages are shown below the *Apply Settings* and *Close* buttons. The settings panel also contains a **Refresh** and **Restore** button at the top-left corner. These buttons can be used to refresh or restore the *selected* configuration of the *selected* node.

3.8.1 Global Settings

By selecting the *Global* configuration option from the sensor tree, the global settings can be edited, as shown in Figure 42:

- **Transmit Data:** Data transmission can be switched off by unchecking the check-box. Nodes keep sampling (i.e. to store data in the flash memory).
- **Sampling Rate (Hz):** Selects the sampling rate used by the sensors. Some sensors may be limited to a lower sampling rate. When using *Synchronous* sampling mode, the default maximum number of nodes supported by the network for a selected sampling rate is shown on the right. The maximum sampling rate is 10.000 Hz.
- **No. of Nodes:** The number of nodes in the network to which the device is currently configured. For gateways this can be modified to match the configuration of the node(s). For nodes this is automatically changed to match the gateway settings. The combination of *Sampling Rate* and *No. of Nodes* determine the number of samples in a radio packet. For best performance, this should be a round number.



- **Sampling Mode:** Inertia nodes can be configured to *Synchronous* or *Stand-alone* sampling. When sampling synchronously, the gateway dictates the time when the nodes take a sample. Nodes do not take samples until a gateway is detected. In stand-alone mode, each node decides on its own when to take a sample.
- **Transmit Type:** Data can be transmitted using *Wireless* (Radio), *USB* or both.
- **Frequency Channel:** Selects the frequency channel used by the Radio. To establish a connection, the channel of the nodes has to be the same as the channel of the gateway. When changing channel, it is recommended to first change the frequency channel of the nodes, and then the channel of the gateway.
- **Disable Radio:** Disable to radio, for example to save power. The device will not be accessible anymore, except via USB.

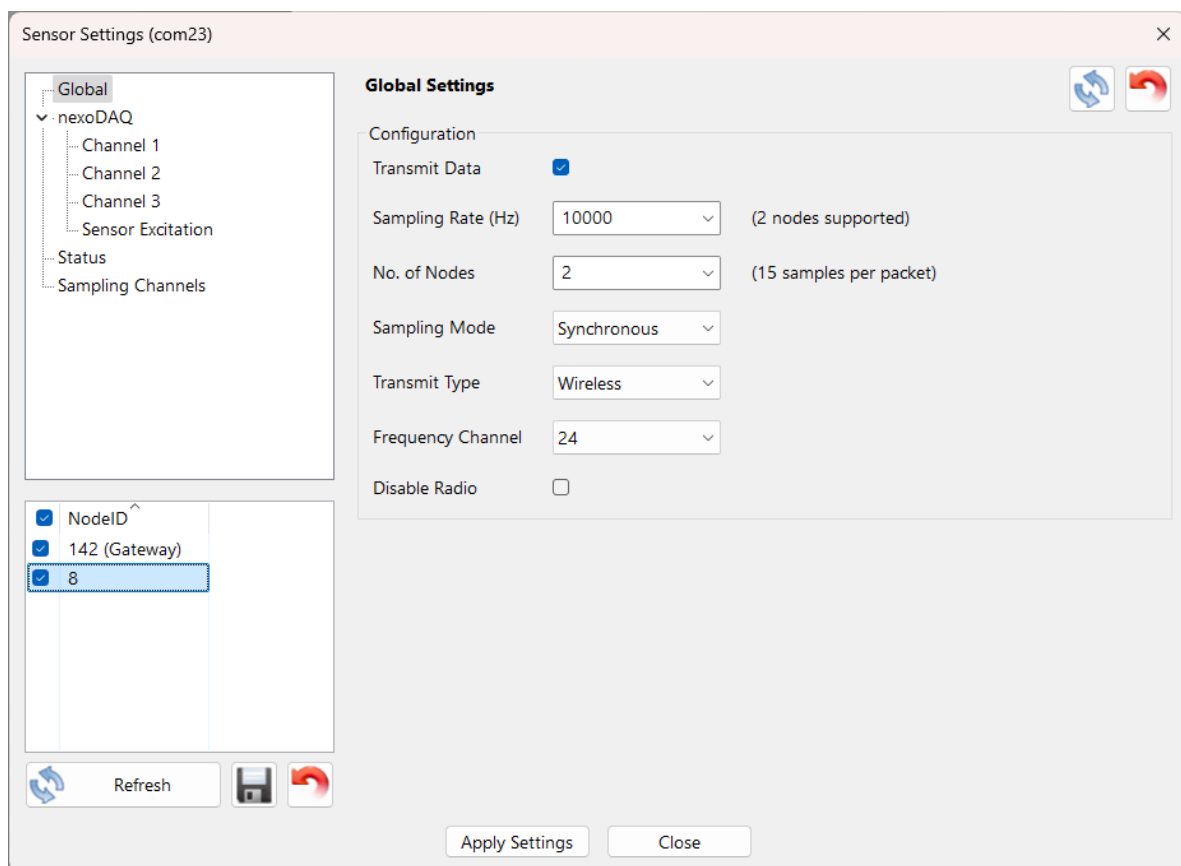

Figure 42: Global Settings



3.8.2 Channel Settings

The *nexoDAQ* provides connections for three analog inputs, which are used for reading external sensors. While Section 2.6 describes the hardware connections for each sensor type, this section details the corresponding software settings.

From the sensor tree, choose the channel number for which the settings are being made: *Channel 1*, *Channel 2* or *Channel 3*.

Some sensors require an external excitation source to produce an electrical output. Use the *Sensor Excitation* settings to adjust parameters related to sensor excitation.

The settings related to a particular channel include a *Configuration* subdivision, with the following options:

- **Enabled:** Enables sampling of the channel.
- **Transmit Data:** If the channel is enabled, data will be transmitted. This is overruled by global transmission settings (see Section 3.8.1).
- **Log to Flash:** If the channel is enabled, data will be logged to flash. See Section 3.4.1 about how to start a flash log.
- **Sampling Rate (Hz):** The sampling rate of the channel (maximum 10000 Hz).
- **Conversion:** The conversion factor used to convert a raw measurement to unit.

The settings associated with each sensor type can be set within the *Channel Setting* subdivision, as detailed in the following paragraphs.

3.8.2.1 ±10 V Differential Signals

For low-voltage ±10 V differential signals, select the *Low Voltage* option from *Channel Settings* and choose *Differential* from the drop-down list *Mode*, as in Figure 43.

The *nexoDAQ* optionally provides positive and negative sensor excitation up to 30V. This can be set by enabling the *Sensor Excitation* option and pressing on the *Configure* shortcut (see also Paragraph 3.8.2.9).

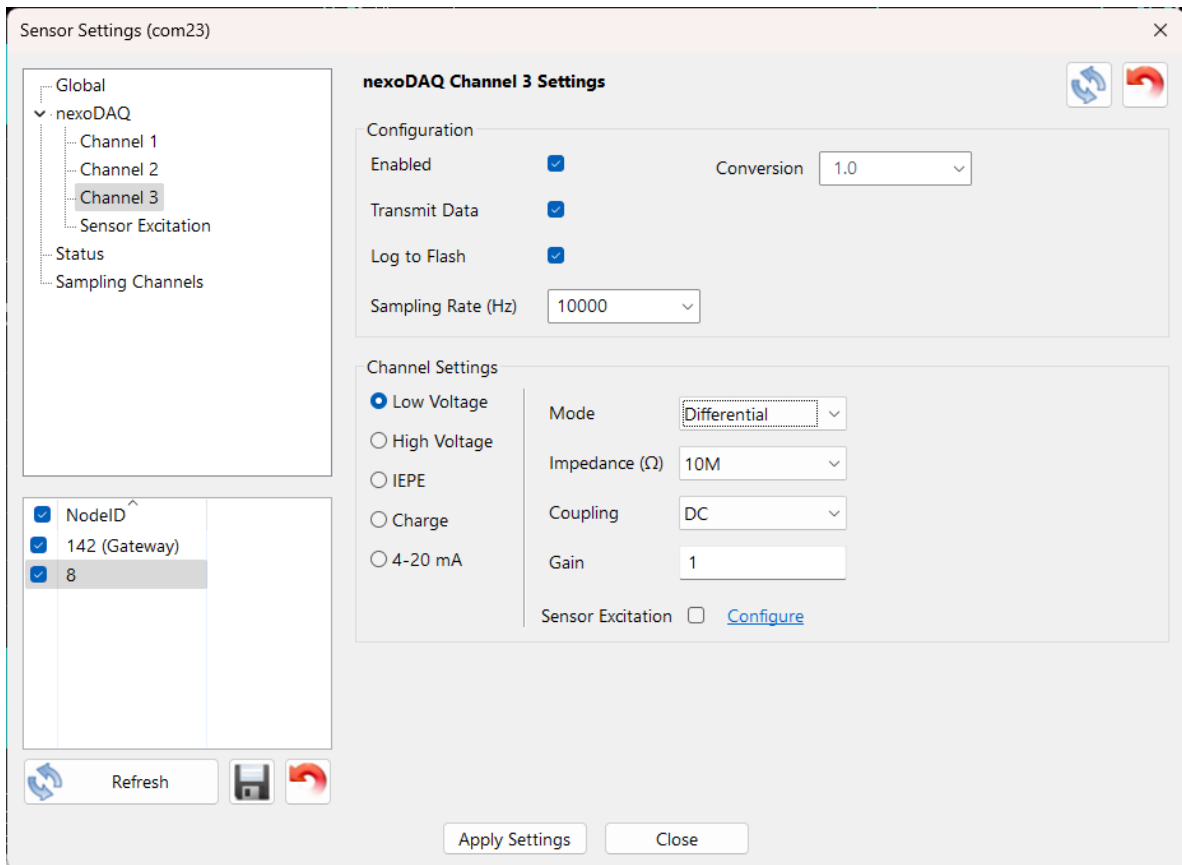

Figure 43: *nexoDAQ* settings for low-voltage ±10 V differential signals

3.8.2.2 ±10 V Single-ended Signals

For low-voltage ±10 V single-ended signals, select the *Low Voltage* option from *Channel Settings* and choose *Single Ended* from the drop-down list *Mode*, as in Figure 44.

The *nexoDAQ* optionally provides positive and negative sensor excitation up to 30V. This can be set by enabling the *Sensor Excitation* option and pressing on the *Configure* shortcut (see also Paragraph 3.8.2.9).

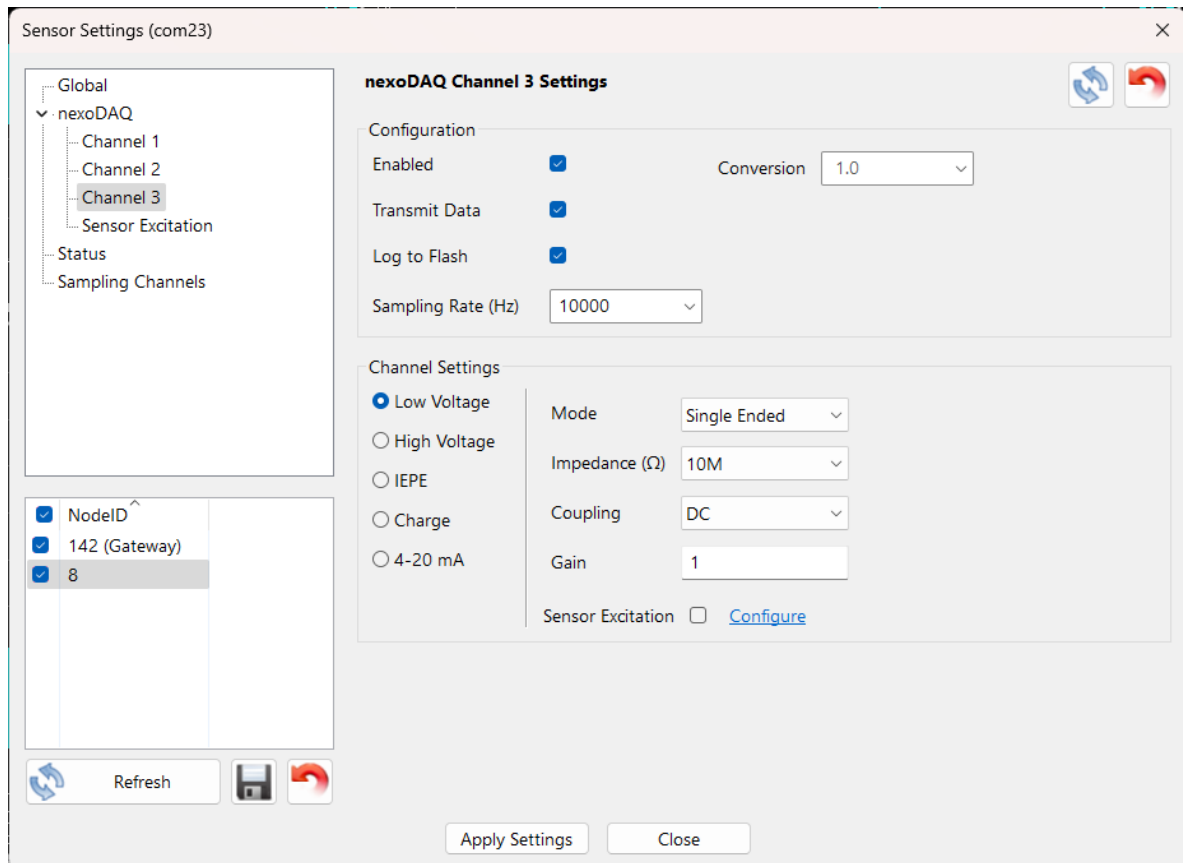

Figure 44: nexoDAQ settings for low-voltage ±10 V single-ended signals

3.8.2.3 Full Bridge

For full-bridge signals, select the *Low Voltage* option from *Channel Settings*, choose *Differential* from the drop-down list *Mode* and enable the *Sensor Excitation* option, as in Figure 45.

The *nexoDAQ* optionally provides bridge excitation from 5 V up to 30V with a maximum load current of 25 mA. This can be set by pressing on the *Configure* shortcut (see also Paragraph 3.8.2.9).

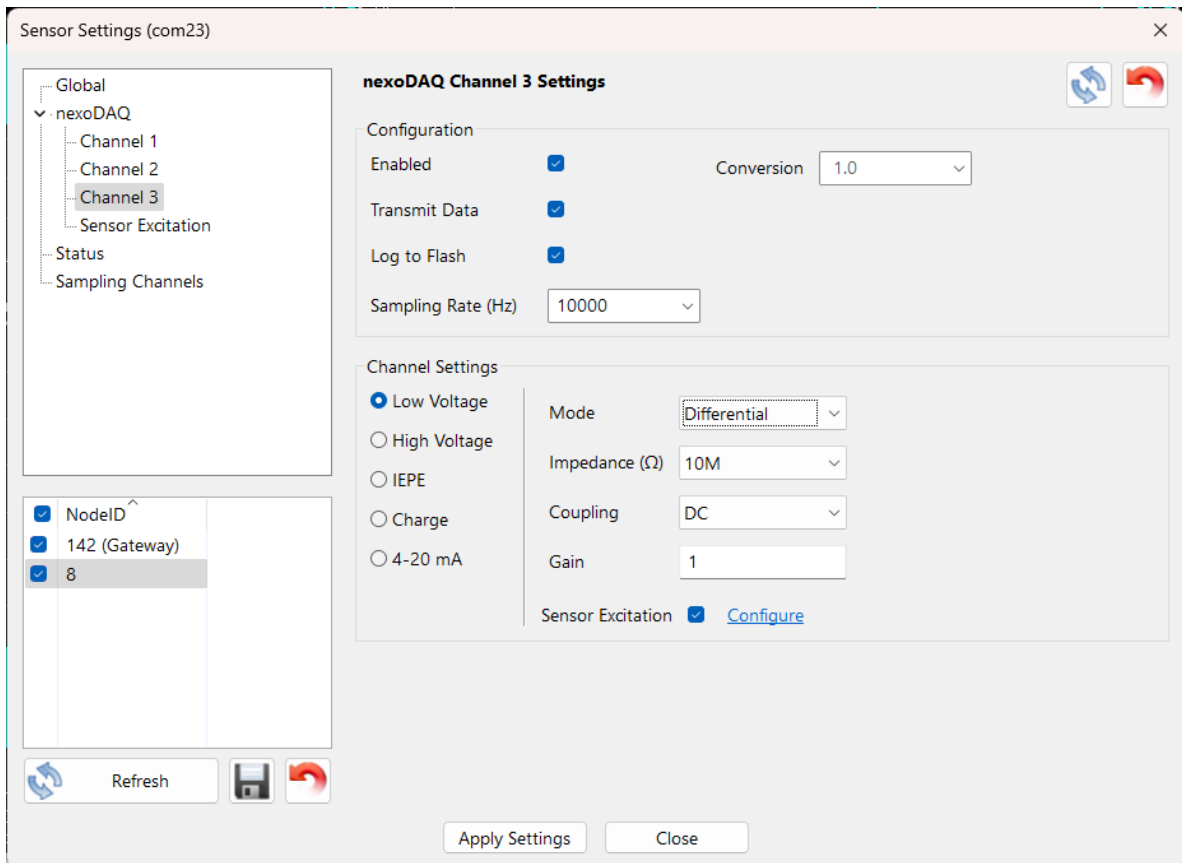

Figure 45: *nexoDAQ* settings for full bridge signals



3.8.2.4 ±100 V Signals

For high-voltage ±100 V signals, select the *High Voltage* option from *Channel Settings*, as in Figure 46. The mode is automatically set to *Single Ended*.

The *nexoDAQ* optionally provides positive and negative sensor excitation up to 30 V. This can be set by enabling the *Sensor Excitation* option and pressing on the *Configure* shortcut (see also Paragraph 3.8.2.9).

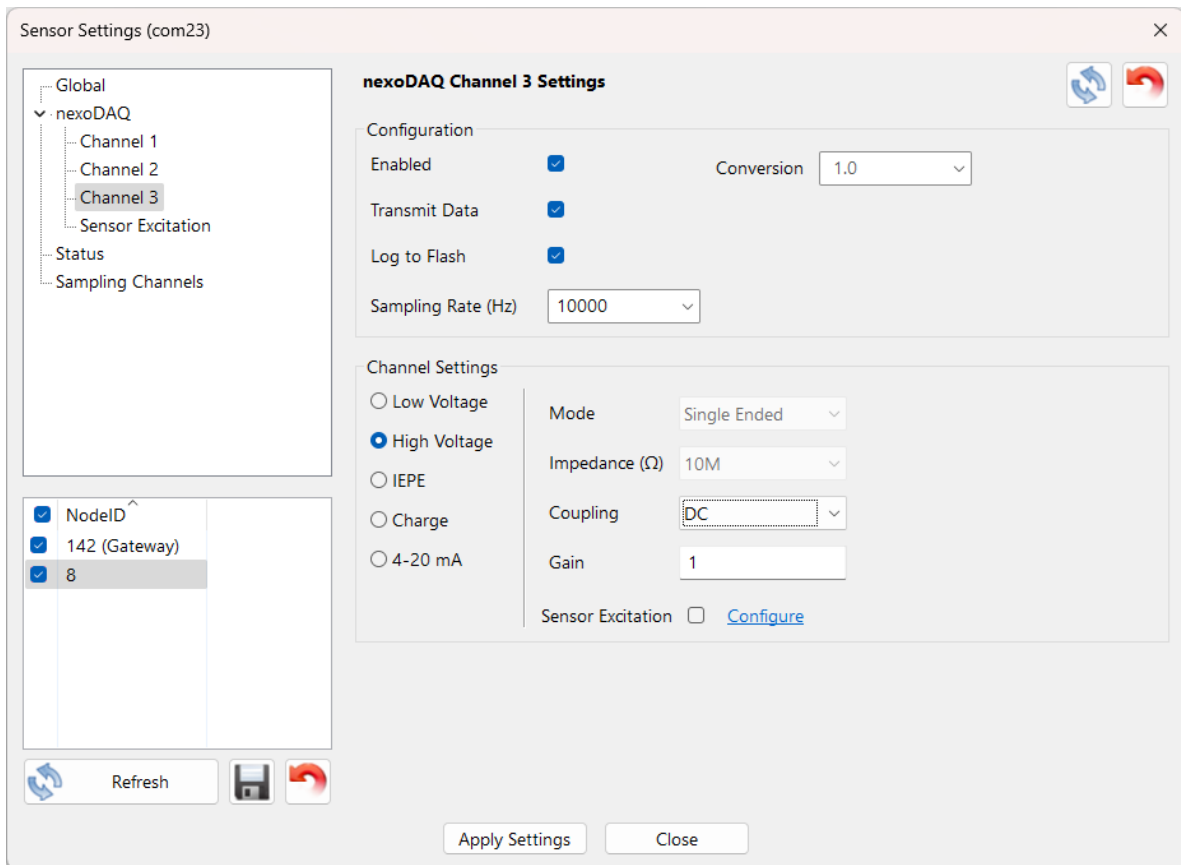

Figure 46: *nexoDAQ* settings for high-voltage ±100 V signals

3.8.2.5 IEPE / ICP® sensors

For IEPE / ICP® sensors, select the *IEPE* option from *Channel Settings*, as in Figure 47. The *Sensor Excitation* option is automatically enabled.

The IEPE voltage can be modified in the *Sensor Excitation* settings window by pressing the *Configure* shortcut (see Paragraph 3.8.2.9).

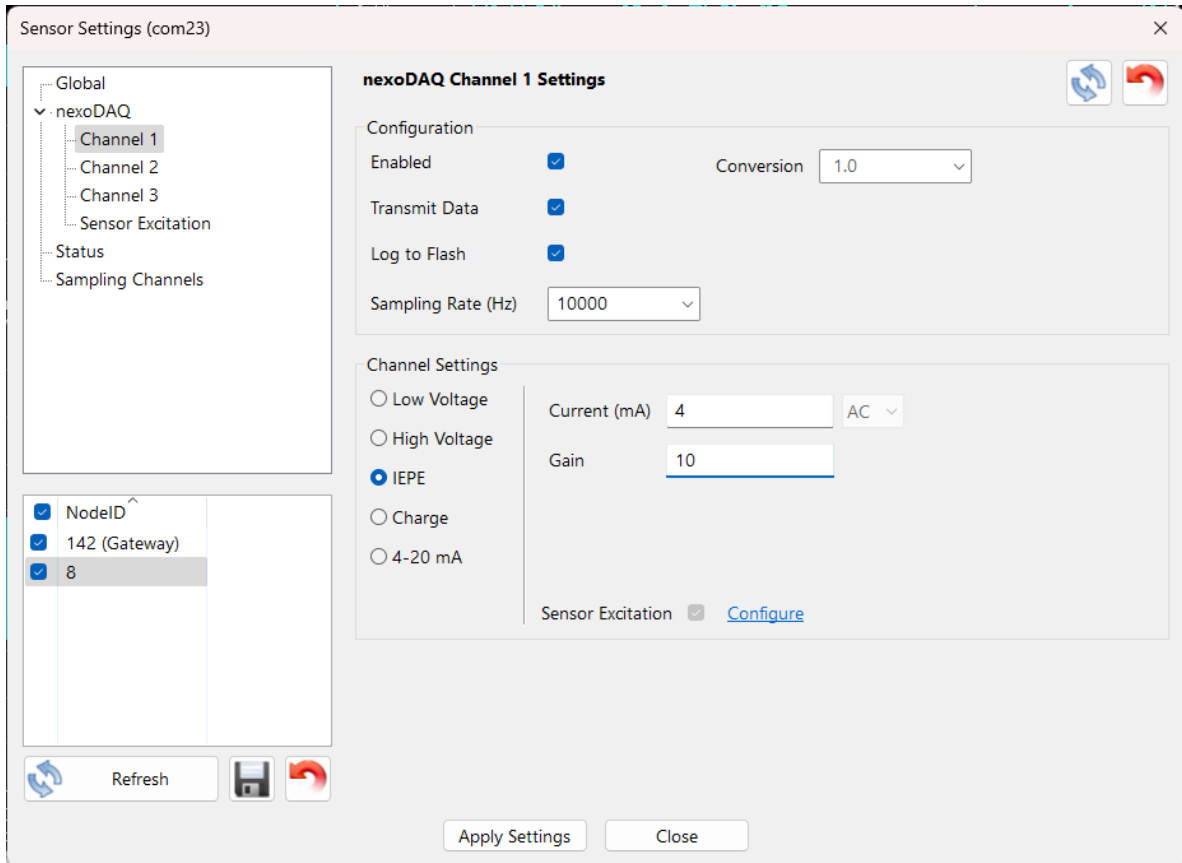

Figure 47: nexoDAQ settings for IEPE / ICP® sensors



3.8.2.6 Differential Charge Signals

For differential charge signals, select the *Charge* option from *Channel Settings* and choose *Differential* from the drop-down list *Mode*, as in Figure 48.

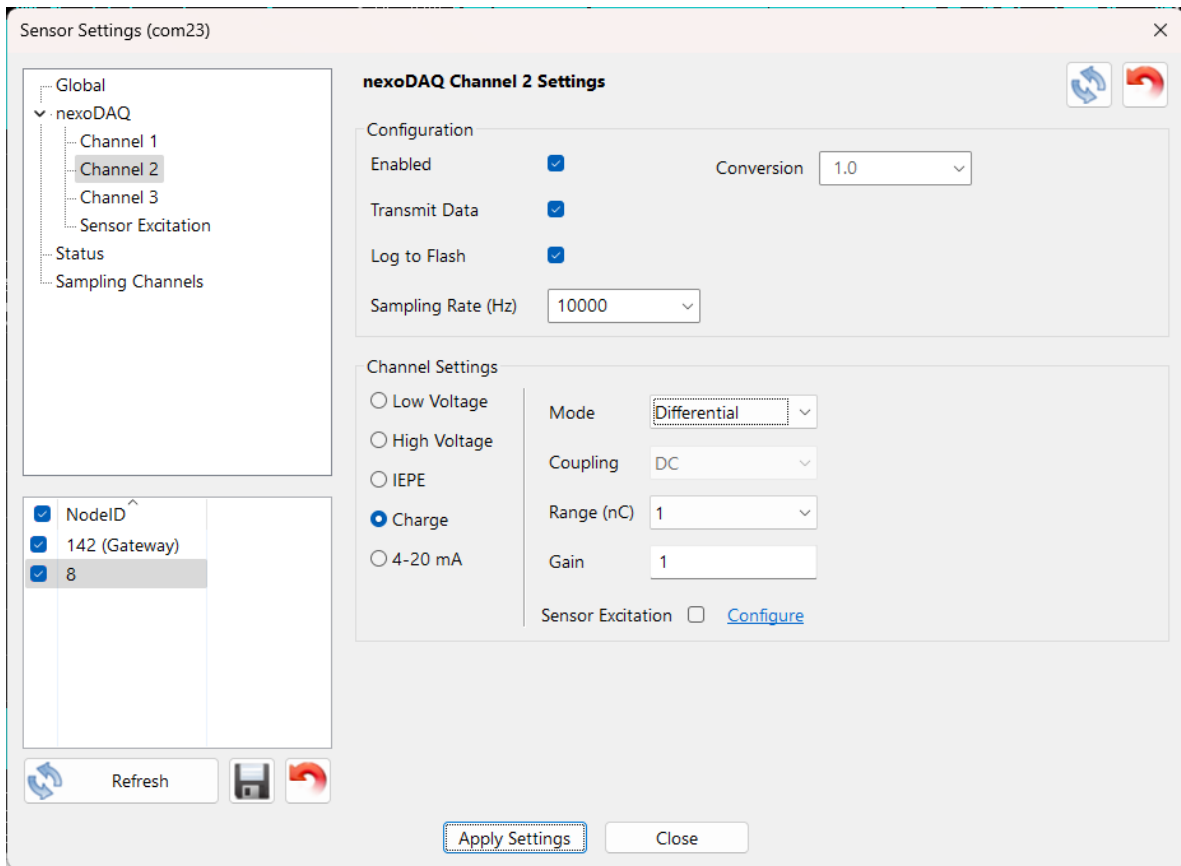

Figure 48: nexoDAQ settings for differential charge signals



3.8.2.7 Single-ended Charge Signals

For single-ended charge signals, select the *Charge* option from *Channel Settings* and choose *Single Ended* from the drop-down list *Mode*, as in Figure 49.

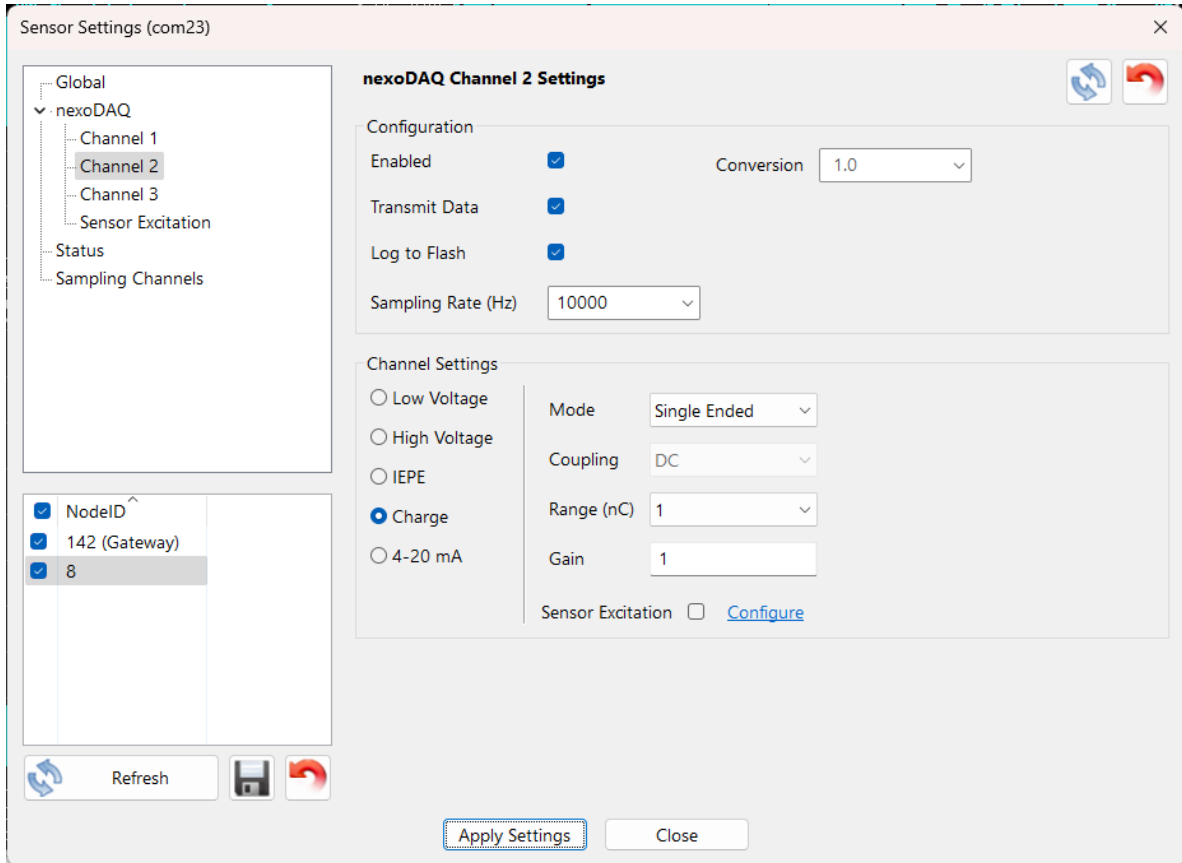

Figure 49: nexoDAQ settings for single-ended charge signals



3.8.2.8 Current Loop (4-20 mA) Signals

For current loop (4-20 mA) signals, select the *4-20 mA* option from *Channel Settings*, as in Figure 50.

The *nexoDAQ* optionally provides current loop sensor excitation up to 15 V. This can be set by enabling the *Sensor Excitation* option and pressing on the *Configure* shortcut (see also Paragraph 3.8.2.9).

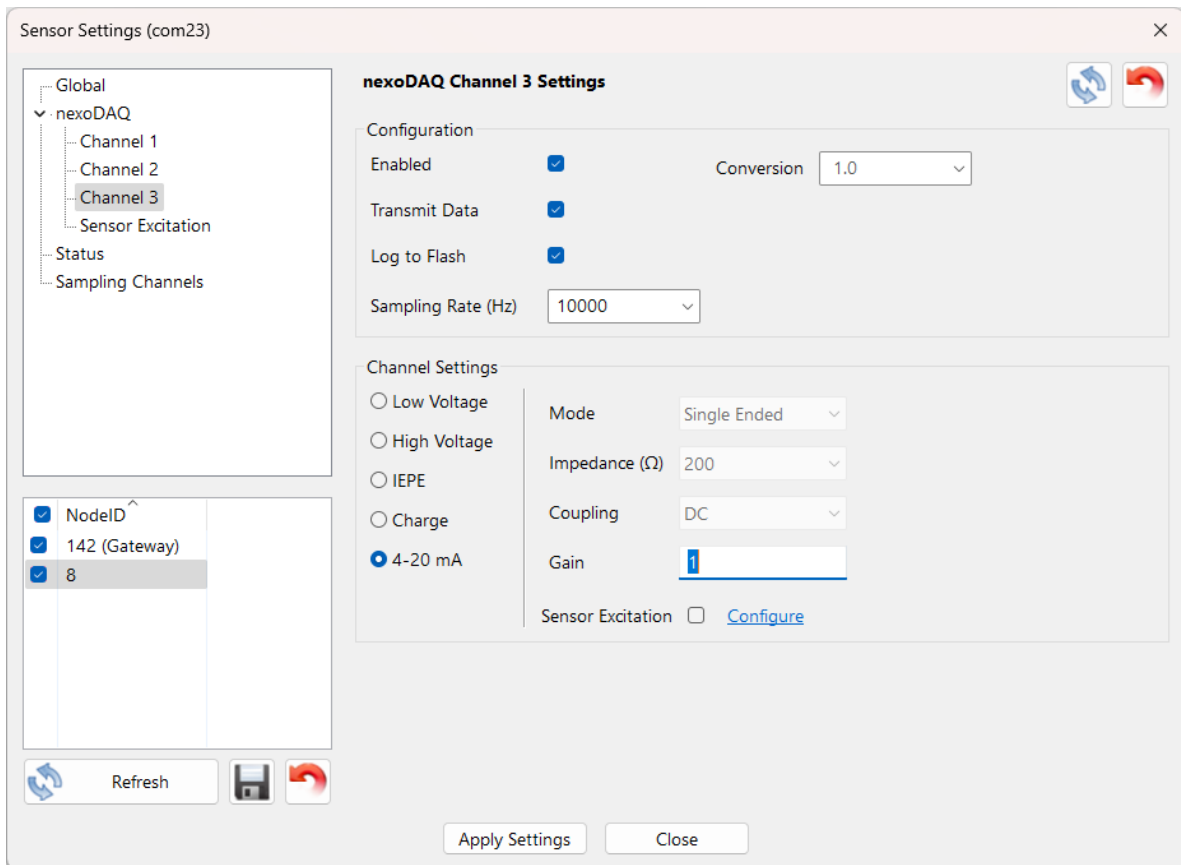

Figure 50: *nexoDAQ* settings for current loop (4-20 mA) signals

3.8.2.9 Sensor Excitation

The settings for *Sensor Excitation* include the adjustment of the built-in IEPE voltage source in the *IEPE Voltage* field, and setting the positive and negative sensor *Excitation Exc+* and *Exc-* (see Figure 51). *Exc+* and *Exc-* are the corresponding pins on the *Lemo* connector, see Table 1 in Section 2.6. These voltage settings are shared across the three channels, but can be individually enabled or disabled per channel in the channel settings.

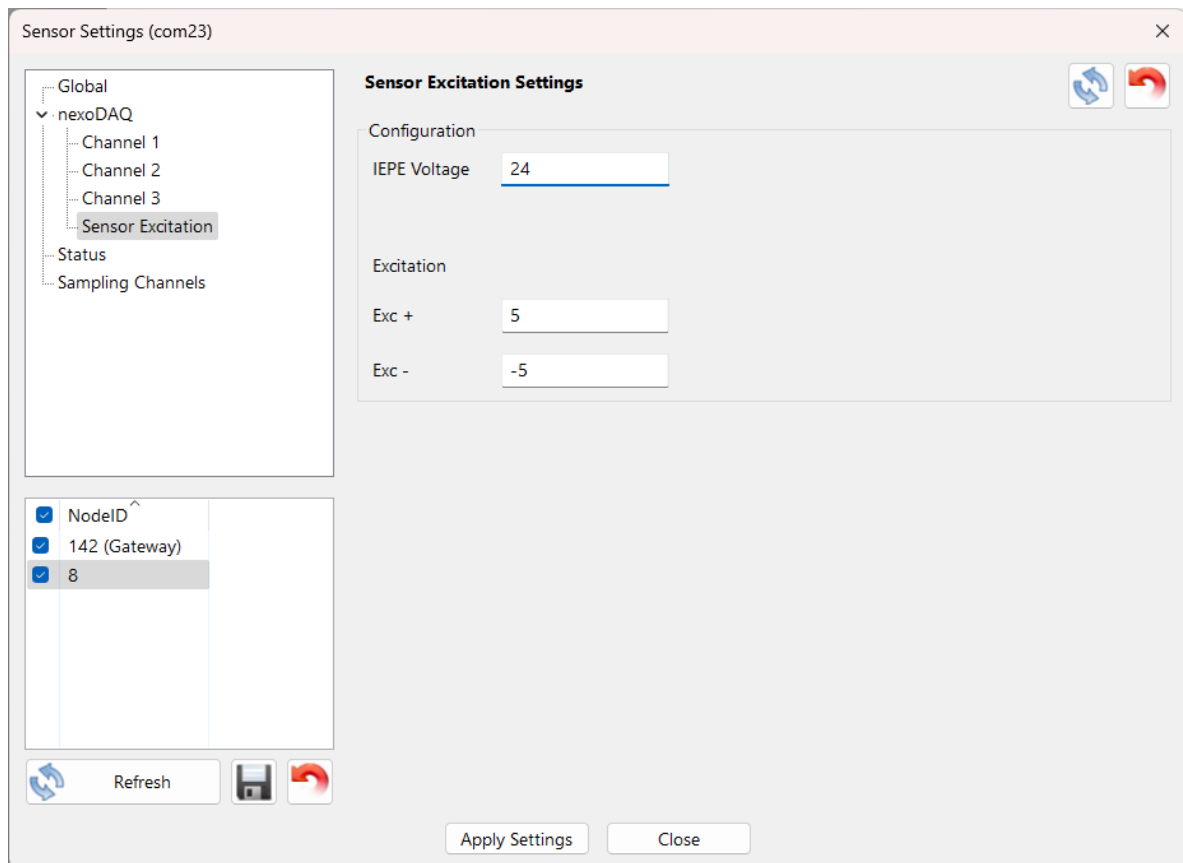

Figure 51: *nexoDAQ* settings for sensor excitation



3.8.3 Status Settings

By selecting the *Status* configuration option from the sensor tree, the settings for status samples can be modified. Status samples consist of the battery level, CPU-temperature and external input detection (e.g. whether USB is plugged in). Figure 52 shows the Status Settings, with the following parameters:

- **Enabled:** Enables the status samples.
- **Interval (s):** The interval in seconds at which status samples are transmitted.

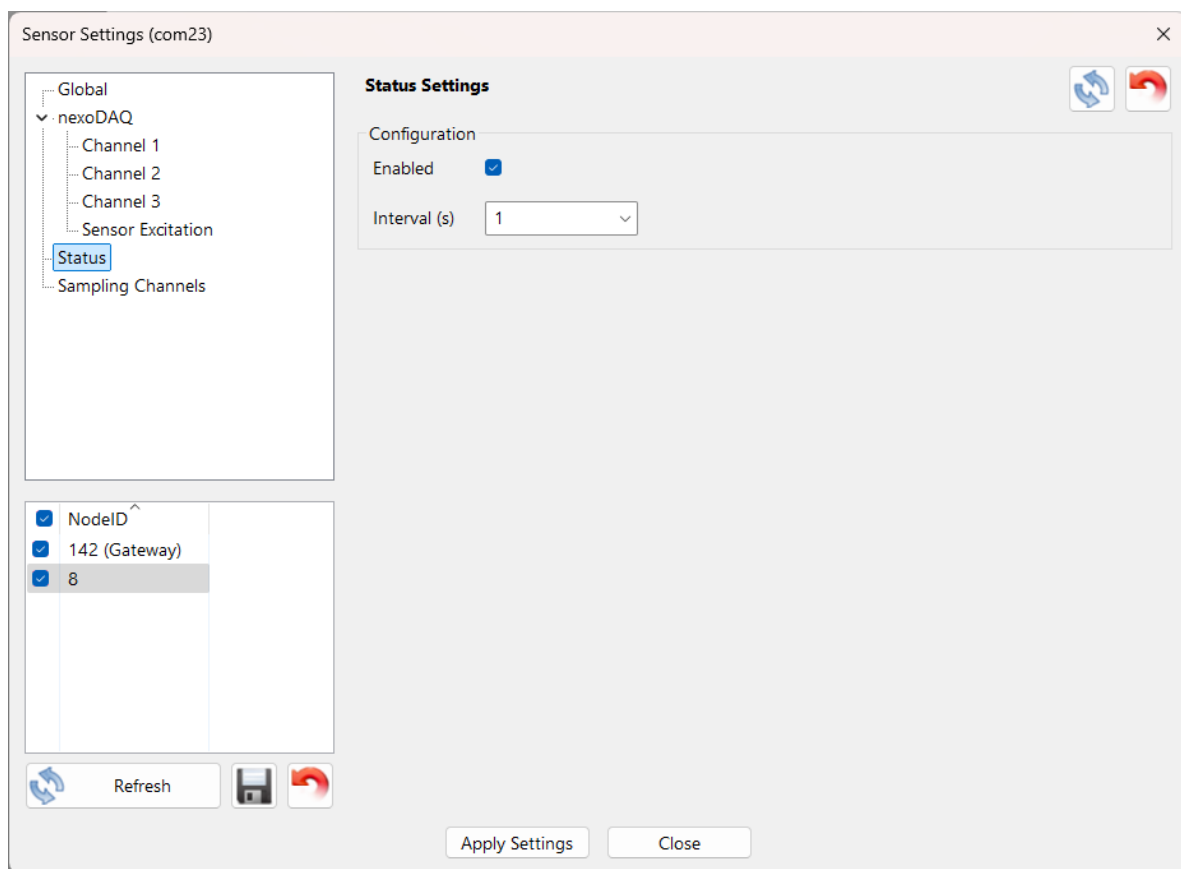

Figure 52: Status Settings



3.8.4 Sampling Channels

nexoDAQ uses sampling channels for each enabled sensor. The *Sampling Channels* information window (Figure 53) shows a summary of the used sampling channels, as follows:

- **Channel:** The channel number assigned to the sensor.
- **Sensor:** The name of the sensor that uses the channel.
- **Wordsize (bit):** The size in bits of one value.
- **Nº Values:** The number of values in a sample.
- **Conversion:** The factor to convert a raw measurement to unit.

The *Status* information is considered to be a separate sampling channel.

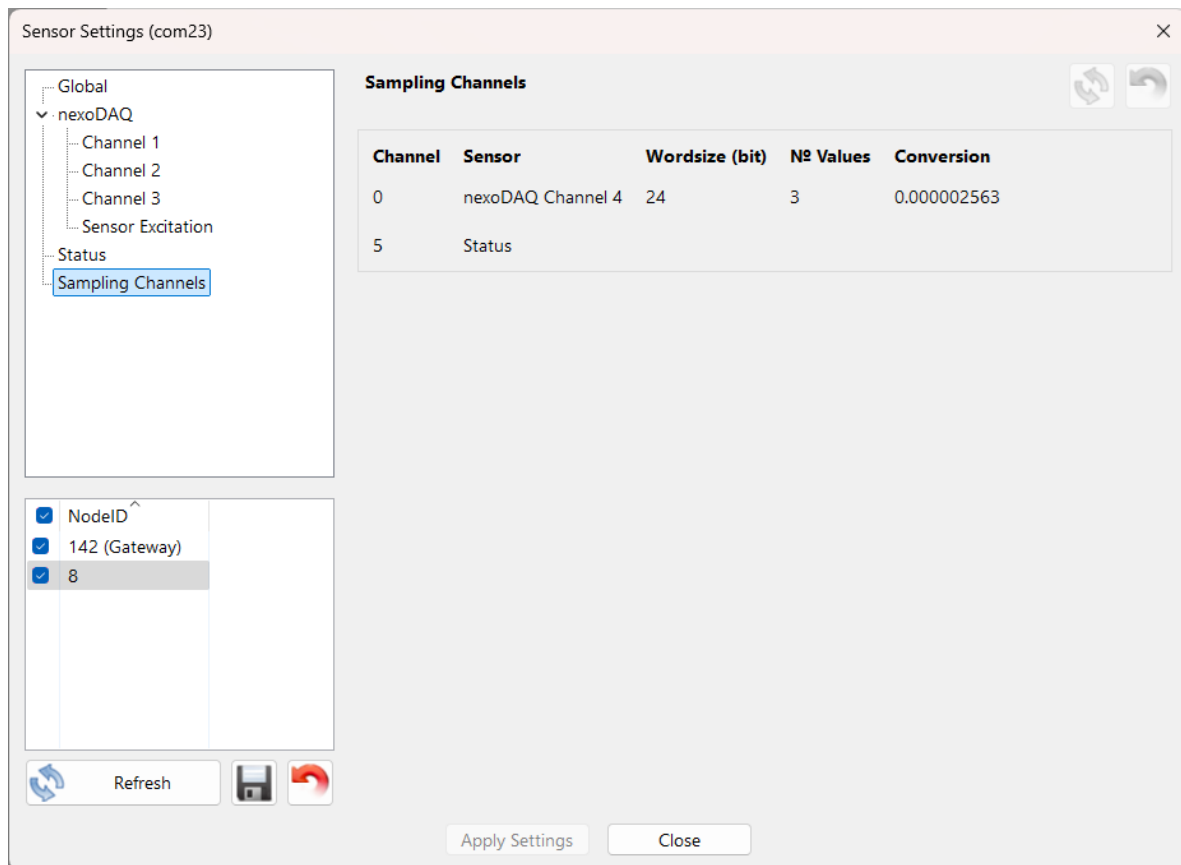

Figure 53: Sampling Channels



3.9 I/O Functionality

The Advanced Inertia Gateway has two BNC I/O ports, each supporting Trigger Output, Trigger Input, Sync Output and Sync Input actions. The I/O ports can be configured for each of these actions in the *Configuration -> I/O Settings* menu, as described in more detail below.

3.9.1 Trigger Output

One or both *EXT SYNC* ports can be configured as Trigger Output in the *Configuration -> I/O Settings* menu. Make sure the correct node and port number are selected, then select *Trigger* and *Output* (see Figure 54).

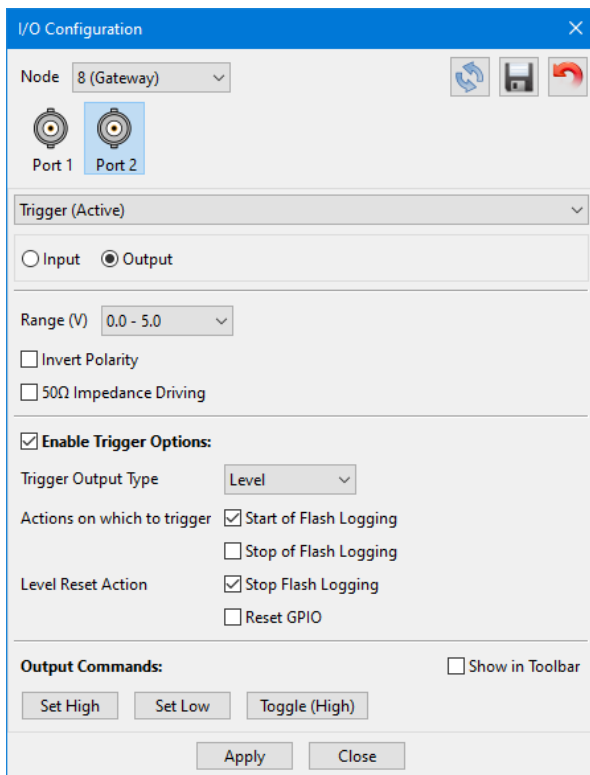

Figure 54: Trigger Output settings

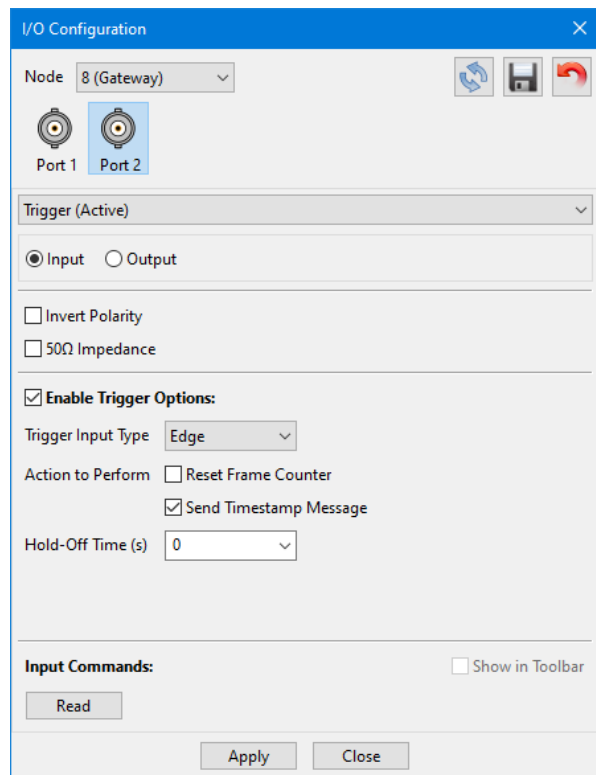

Figure 55: Trigger Input settings

Trigger (Active) means that it is already the current selection. Several voltage ranges are possible up to a maximum range of -10 V to $+10\text{ V}$. Further options exist for inverting polarity and $50\ \Omega$ impedance driving. The impedance can be set to very high ($> 1\ \text{G}\Omega$) by deselecting the $50\ \Omega$ impedance.

For the trigger signal itself there are some options as well. Enable the trigger options by checking *Enable Trigger Options*. The trigger type can be either *Pulse* or *Level*. It can be activated in several ways: combined with starting or stopping flash logging, or set manually using the I/O buttons in the toolbar (see Figure 56).

The buttons in the toolbar can be enabled via the menu (*View -> Toolbar -> Show I/O Buttons*)



or directly in the *I/O Configuration* window by checking the checkbox *Show in Toolbar*.



Figure 56: Inertia Studio toolbar with I/O Buttons

If the signal is successfully set, a message indicating success appears in the notification area. If the signal is set during logging to file, the event is stored in the log file.

The trigger events are not stored in the flash memory of the nodes. Instead, when starting a flash log, the output signal can automatically be set to *high*. When stopping a flash log, the output signal can be set to *low*. To achieve this, check the checkbox of the gateway in the *Logging to flash* window (see Section 3.4.1) before pressing *Start* and *Stop*.

3.9.2 Trigger Input

One or both *EXT SYNC* ports can be configured as Trigger Input in the *Configuration -> I/O Settings* menu. Make sure the correct node and port number are selected, then select *Trigger* and *Input* (see Figure 55). *Trigger (Active)* means that it is already the current selection. Options are available for inverting polarity and 50 Ω input impedance. The input impedance can be set to very high ($> 1 \text{ G}\Omega$) by deselecting the 50 Ω impedance. Enable the trigger options by checking *Enable Trigger Options*. For the trigger input type currently just one option is supported, namely *Edge*.

If *Enable Trigger Options* is active, several actions can be performed when a trigger is received:

Reset Frame Counter resets the frame counter as well as the time stamps to 0;

Send Timestamp Message sends a time-stamped message to Inertia Studio, which will then appear in the notification area and, if data is being logged by Inertia Studio, in the log file as well.

If the *Hold-off time* is set to 0, the action is performed immediately after the trigger is received. Otherwise, the action is performed after the delay time that is specified here.

3.9.3 Sync Output

One or both *EXT SYNC* ports can be configured as Sync Output in the *Configuration -> I/O Settings* menu. In this mode, a periodic clock signal can be sent to connected devices for synchronization. Make sure the correct node and port number are selected, then select *Sync* and *Output* (see Figure 57).

Sync (Active) means that it is already the current selection. Several voltage ranges are possible up to a maximum range of -10 V to $+10 \text{ V}$. Further options exist for inverting polarity and 50 Ω impedance driving.



Finally, the *Sync frequency* and its *Phase shift* can be set to a value between 1 and 1500 Hz for the frequency and at most 1 second for the phase shift.

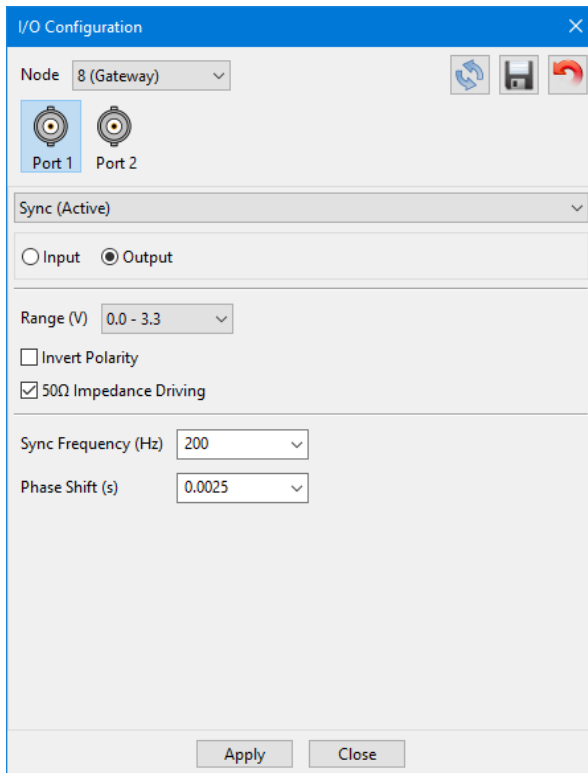

Figure 57: Sync Output settings

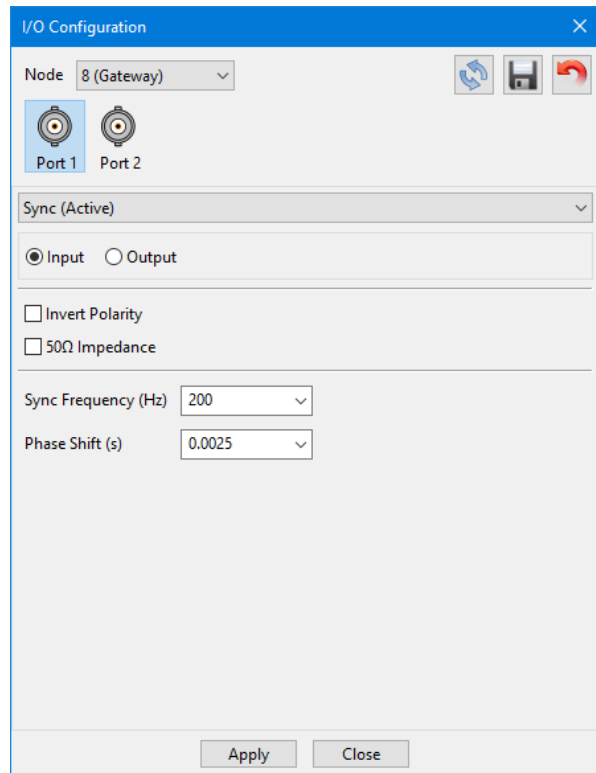

Figure 58: Sync Input settings

3.9.4 Sync Input

Any one *EXT SYNC* port (but not both together) can be configured as Sync Input in the *Configuration -> I/O Settings* menu. In this mode, a periodic clock signal can be received from an external device for synchronization. Make sure the correct node and port number are selected, then select *Sync* and *Input* (see Figure 58). *Sync (Active)* means that it is already the current selection. Options are available for inverting polarity and 50 Ω input impedance, similar to the other synchronization configurations.

Finally, the *Synchronization frequency* and its *Phase shift* can be set to a value between 1 and 1500 Hz for the frequency and at most 1 second (or less, depending on the frequency) for the phase shift. The given frequency and phase shift are used by the synchronization algorithm in the Gateway to determine what the incoming reference clock signal represents. The timing of the whole system will then be based on this reference.



3.10 The Tracker

The *Tracker* window is not applicable to a nexoDAQ device.

3.11 GNSS Map

The *GNSS Map* window is not applicable to a nexoDAQ device.

3.12 Appearance and Preferences

The appearance of the plots can be changed via the *Preferences* and the *Layout Configuration* windows. The following sections present the configuration options of both windows in detail.

3.12.1 Layout Configuration

The *Layout Configuration* window is accessible from the toolbar and via the menu *View*, item *Layout Wizard*. Section 3.12.1 describes how this option can be used to change the type and number of plots that are shown in the main screen.

The layout wizard makes it easy to quickly switch between layouts, or to make a custom screen layout. Simply select one of the predefined layouts from the list and press the *Finish* button. The relevant layouts for *nexoDAQ* are:

- **Analog Inputs + FFTs (3x):** Plots for the first three analog inputs, and for their FFTs.
- **Empty Screen:** No plots are shown.
- **Custom Layout:** The number of plots, the type of sensor data and the location on the main screen can be chosen by the user.

Figure 59 shows the layout wizard set for *Custom Layout*. A custom layout can be created either by modifying the number of visible rows and columns or by changing the plot type using the *Change* button.

In the latter case, the *Plot Selection* window appears, allowing the selection of a different plot type. When the *Only show available sensors* selection box is checked, the window shows only the available sensor types of the connected nodes. Otherwise, the window shows all the available plot types.

Processed data can also be shown in the plots. For each ADC input, the **FFT** (Fast Fourier Transform) can be applied to raw sensor analog signals (see Section 3.12 for changing the FFT settings)

The *Y-axis label* of each plot can be modified, with the constraint that it must be unique. By pressing the yellow arrow, the label resets to its default value.

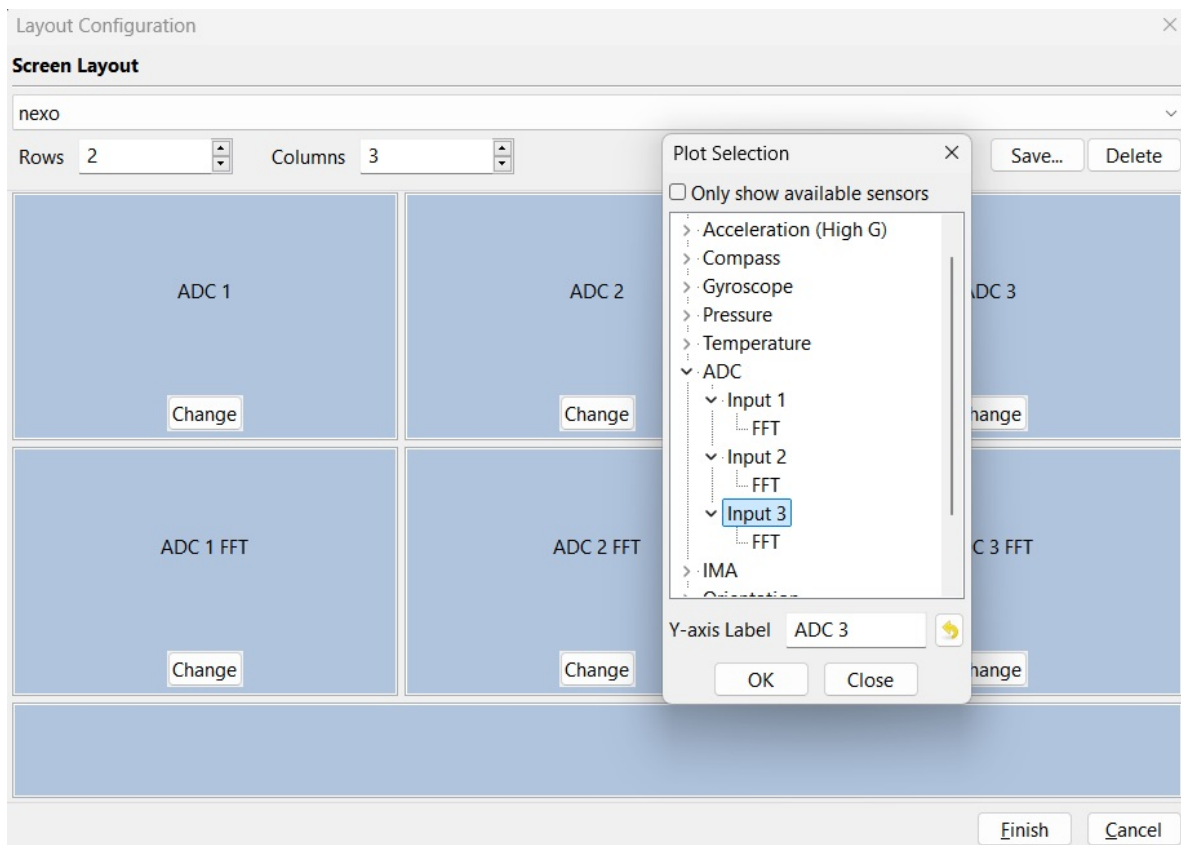

Figure 59: Layout Wizard with custom layout and Plot Selection window



3.12.2 Preferences

The *Preferences* window is accessible from the toolbar and via the menu *Configuration*, item *Preferences*. The four tabs of the *Preferences* window are described in the following sections. After any modification of the preferences, press the *Apply* button to apply them. Press the *Close* button to discard all changes.

3.12.2.1 Global

In the *Global* tab, the following preferences can be edited:

- **Small Icons in Legend:** Shows small or large icons in the legend.
- **Automatically Check for Updates:** Checks every week if a new version of Inertia Studio is available.
- **Store Sensor Settings Automatically:** Automatically stores the sensor settings permanently on the node(s), 15 seconds after applying.
- **Automatically Open Export Window:** Open the *Export Logfiles* window (see Section 3.6 when an Export starts.
- **Show Network Adapters:** Shows the network adapters that can be used to connect to an Advanced Inertia Gateway via Ethernet.
- **Down Sampling:** A number of samples can be averaged before showing them in the plot. This improves performance, but shows a flattened signal. Down sampling cannot be applied to FFT plots and has no effect on the values in the log files.
- **Sample Loss Interval (s):** Sets the interval in seconds used for the accumulation of lost samples and calculation of the sample loss percentage, shown in the legend.
- **Plot History (s):** Sets the maximum number of seconds of data to show in the plot (visible when panning the plot).
- **Register File Extensions:** Registers the *itlog* and *fwu* (firmware update file) file extensions to Inertia Studio.

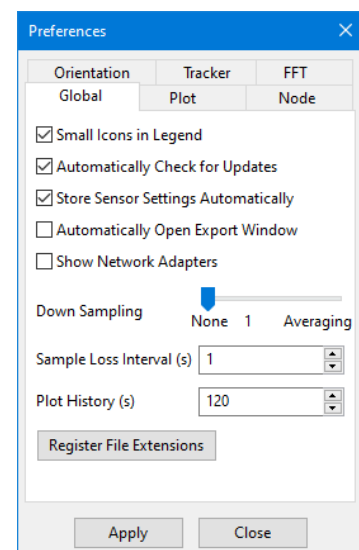

Figure 60: Global Preferences



3.12.2.2 Plot

In the *Plot* tab, the following preferences can be edited:

- **Auto Scaling on Y-axis:** Automatically adapts the limits of the Y-axis to the minimum and maximum value of each plot.
- **Show Minutes on X-axis:** Use minutes for the X-axis timestamp, instead of only seconds.
- **Show X-axis Grid:** Shows grid lines on the X-axis (vertical lines).
- **Show Y-axis Grid:** Shows grid lines on the Y-axis (horizontal lines).
- **Enable Anti-Aliasing:** Enables anti-aliasing to smoothen the plots.
- **Show Gaps when Samples are Lost:** When samples are lost, show a gap in the plot instead of connecting the points directly.
- **Multi-Threaded Rendering:** Uses multiple threads to render the plots.
- **Hardware Acceleration:** Uses the graphics card of the PC to draw the lines in the plots. Select which rendering method to use.
- **Background Colour:** Changes the colour theme to a black background with white axes, or a white background with black axes.
- **Update Speed:** Modifies the speed at which the plots are updated. Setting the slider closer to *Slow* increases the performance on a slow or overloaded PC (e.g. when showing many plots or many nodes).

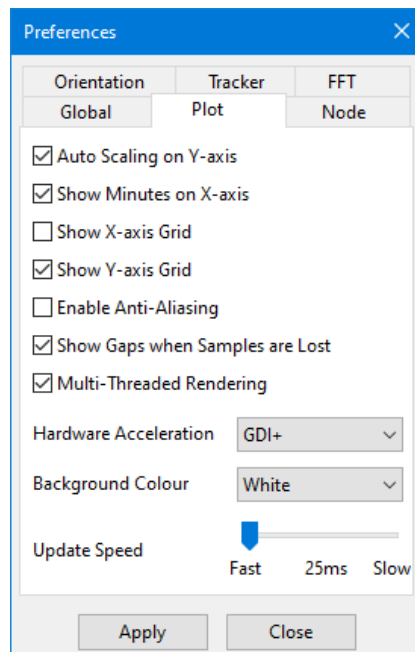

Figure 61: Plot Preferences

3.12.2.3 Node

In the *Node* tab, the following preferences can be edited:

- **Node number:** Selects a node number for changing its preferences.
- **Description:** A description of the selected node that will be shown in the legend. The yellow arrow will clear the description.
- **Line colour:** Selects the colour to use in the plots for the selected node. The yellow arrow will reset the colour to the nodes default colour.
- **Reset for All Nodes:** Resets the colour and description of all nodes to their default values.

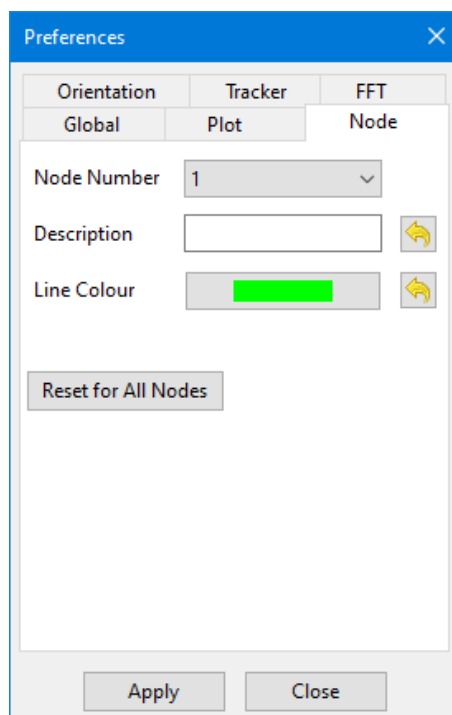

Figure 62: Node Preferences



3.12.2.4 Orientation

In the *Orientation* tab, the following preferences can be edited:

- **Enable Orientation Calculation:** Enables calculating the orientation.
- **Use Compass:** Uses data from the compass for orientation calculation.
- **Reduce Yaw Drift in Rest:** Reduce the yaw-drift when the gyroscope is in rest (all axes at 0). Very small measurements will be ignored.
- **Reset Orientation in Rest:** Resets the orientation when the node stops rotating.
- **Initial Yaw Angle (°):** Sets the initial *yaw* angle (irrelevant when compass is enabled).
- **Algorithm:** Select the algorithm to use to calculate the orientation quaternions.
- **Parameters:** Opens a dialog to modify the parameters of the orientation algorithms.

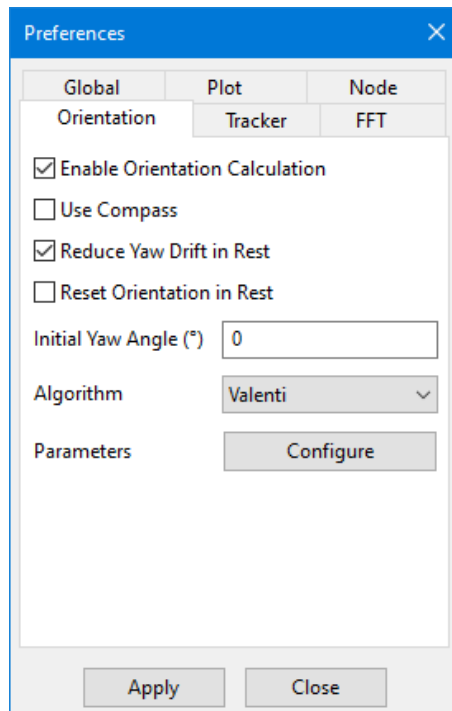

Figure 63: Orientation Preferences



3.12.2.5 Tracker

In the *Tracker* tab, the following preferences can be edited:

- **Show Node Numbers:** Shows the node number next to the 3D model.
- **Show Angles:** Shows the Euler angles (*roll, pitch, yaw*) in the tracker. In the *Tracker* window, only one node should be selected.
- **Show Wireframe:** Shows the 3D model as a wireframe.
- **Show Axes:** Shows the axes of the ground plane.
- **Use Custom Model:** Chooses a custom 3D model to show instead of the model. The model should be in Wavefront .obj format¹. After loading, the 3D model is centered and scaled to fit in the tracker.
- **Background Colour:** Changes or resets the background colour of the tracker.
- **Model Size:** Increases or decreases the size of the 3D model.

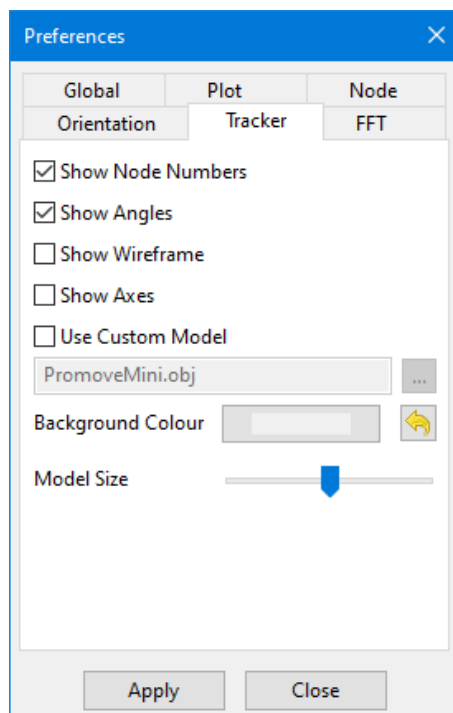

Figure 64: Tracker Preferences

¹The .obj file should start with three-coordinate vertices followed by three-elements faces. The easiest method to create these files is using MeshLab. First, open or import the model. Then go to the *File* menu and select *Export Mesh (As)...* Select *Alias Wavefront Object (*.obj)* as filetype. In the next window, deselect everything (or select *None*) and press *OK*.

3.12.2.6 FFT

In the *FFT* tab, the following preferences can be edited:

- **Window Function:** Selects the window function used by the FFT algorithm. The available options are: *Rectangular*, *Triangular*, *Hamming*, *Hanning* and *Blackman*.
- **X-axis Scale:** Selects the scale of the X-axis as a linear or a logarithmic scale (in decibel).
- **Y-axis Scale:** Selects the scale of the Y-axis as a linear or a logarithmic scale (in decibel).
- **FFT Points (2[^]):** The number of samples used as input for a FFT calculation (2^{FFT Points}).
- **FFT Interval (s):** The time in seconds between subsequent FFT calculations.
- **Remove DC:** Reduce the 0-component by removing the mean DC signal.
- **FFT Averaging:** The number of FFTs to average when plotting.

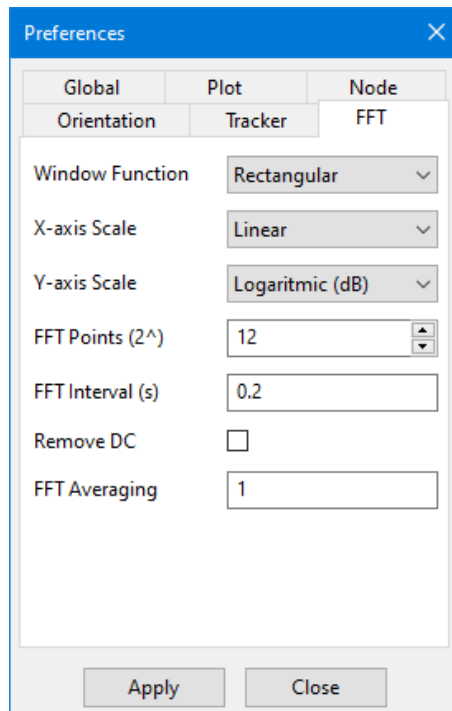

Figure 65: FFT Preferences



3.13 Updating the Firmware

The firmware can be updated for all the Inertia devices (e.g. the Inertia Gateway and *nexoDAQ* devices). The firmware is available for download from the Downloads page of the Inertia Technology website: <https://inertia-technology.com/downloads/>.

The firmware can be updated either using USB or wirelessly. When updating the firmware of *nexoDAQ*, it is recommended to use the **USB connection** (see Section 3.2 for details about connecting to USB).

The *Firmware Update* window can be accessed from the *Help* menu (Figure 66). Available devices are listed on the left, from current and previously opened connections. The icon indicates if a device is connected via USB or wirelessly. When available via both, the USB connection is used. Use the refresh button in the bottom left to clear the connections and devices from the list and refill it with currently opened connections and available devices.

Information about the selected device, including its hardware type, current firmware version, and optional build options is shown in the *Information* box. When a firmware update file (*.fwu) is selected, its targeted hardware type and firmware version is shown as well.

Use the *Details* button to show more information about the device and firmware file, such as hardware revision and a list of firmware components.

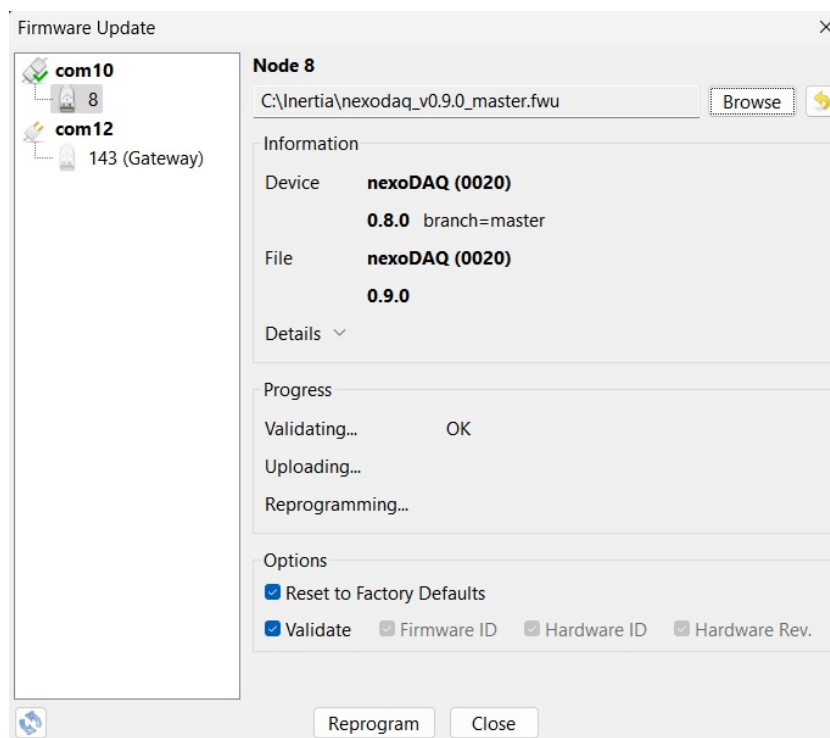

Figure 66: Firmware Update

If no firmware is selected, the device can be reset to its factory defaults by checking *Reset to Factory Defaults* and pressing *Reset*. After resetting, the device has to be manually restarted



for the changes to take effect.

The *Progress* box shows information about validating, uploading and reprogramming. When a node is connected and a file selected, *Validating...* shows whether the file is valid and if the supported hardware matches the connected hardware. If valid, the *Reprogram* button becomes enabled. Once the button is pressed, *Uploading...* shows the progress of uploading the firmware to the device. If the upload is successful, the device disconnects and updates the firmware while a *Reprogramming...* countdown timer is shown. When finished, the device reboots and reconnects, and the new firmware information appears in the *Information* box. Only one device per connection can be updated at once, while others will be queued.

Do not disconnect or turn off the device during reprogramming!

Reset to Factory Defaults clears the current settings and loads the default settings of the new firmware once reprogramming is finished. This reset can also be forced by the firmware update file. In this case, the checkbox cannot be modified. Firmware validation can be disabled to allow programming an unsupported firmware. This could disable the device and should only be done when instructed to do so.

If the firmware update resets the sensor settings, the wireless channel is also reset to the factory settings. After a successful update, if the gateway and the sensor node are on different wireless channels, the sensor node becomes unreachable. For changing the wireless channel of an Inertia device, see Section 3.8.1.

Firmware update does not work if the device does not have internal flash memory, if the internal flash memory is full or (for older firmware) when the maximum number of files is reached.

4 Performing an Experiment

This section describes how to perform an experiment and how to read and align the data obtained from the experiment.

4.1 Basic steps for making an experiment with *nexoDAQ*

In the following, we explain how to make a measurement with a *nexoDAQ* device and a 3-axial IEPE/ICP® accelerometer sensor.

1. Connect the antenna to the gateway by using the screw-type coupling mechanism. Connect the gateway to the PC using the mini-USB cable. The power light of the gateway turns blue (Figure 67).



Figure 67: Gateway connected to PC



2. Start Inertia Studio. Using the layout wizard, select the predefined layout **Analog Inputs + FFTs (3x)** from the list (Section 3.12.1), see Figure 68.

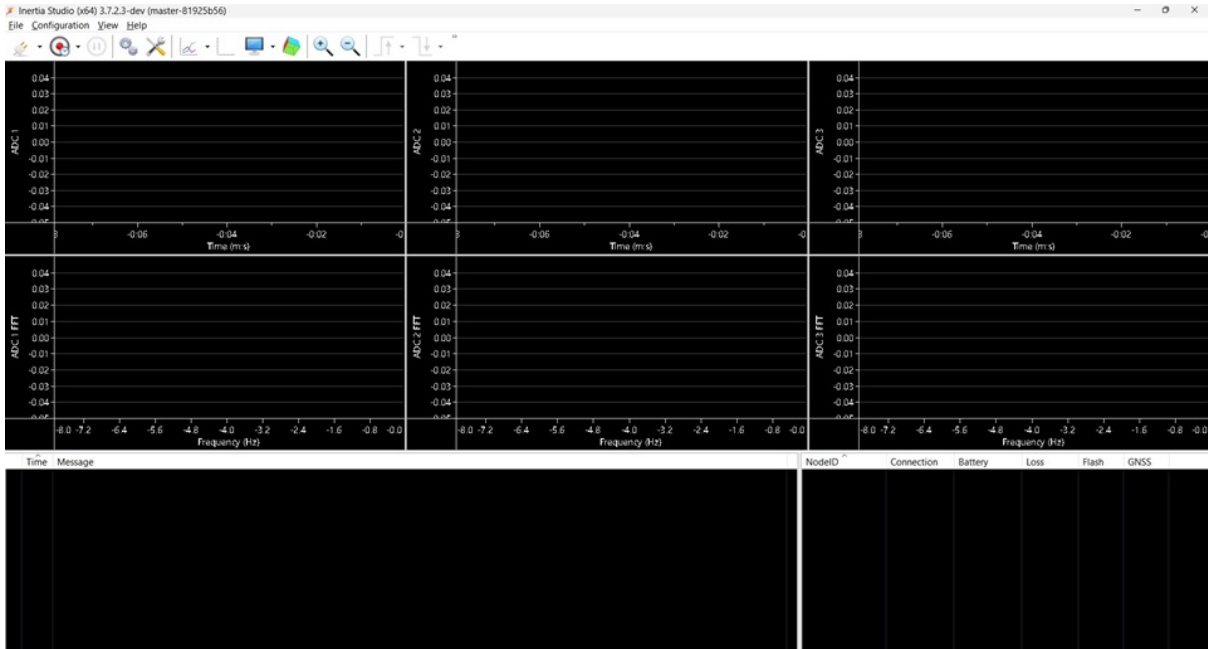

Figure 68: Inertia Studio layout for *nexoDAQ*



3. Connect the gateway in Inertia Studio (Figure 69) by pressing on the arrow next to the first *Connect* pictogram button in the toolbar, which opens the drop-down menu with a list with the names of the available Inertia devices. Select the **Inertia Gateway** device and press on the *Connect* pictogram (for details, see Section 3.2.1).

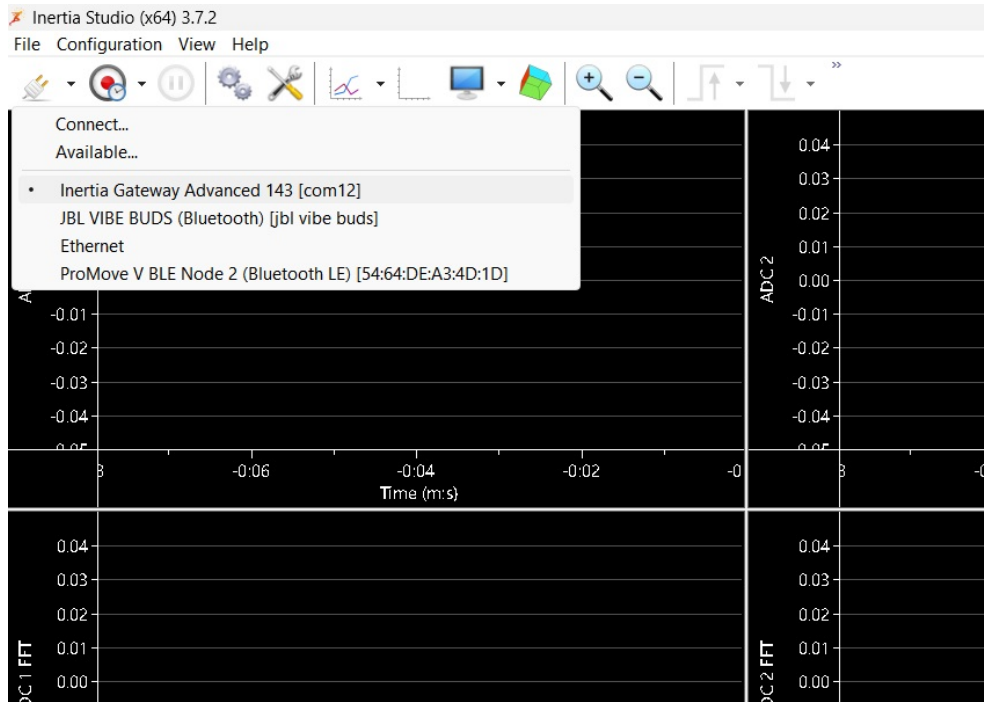

Figure 69: Connect the gateway in Inertia Studio

4. Power-up the *nexoDAQ* device.



Figure 70: Power up *nexoDAQ*



5. Signals are coming in Inertia Studio, but no sensor is connected yet.

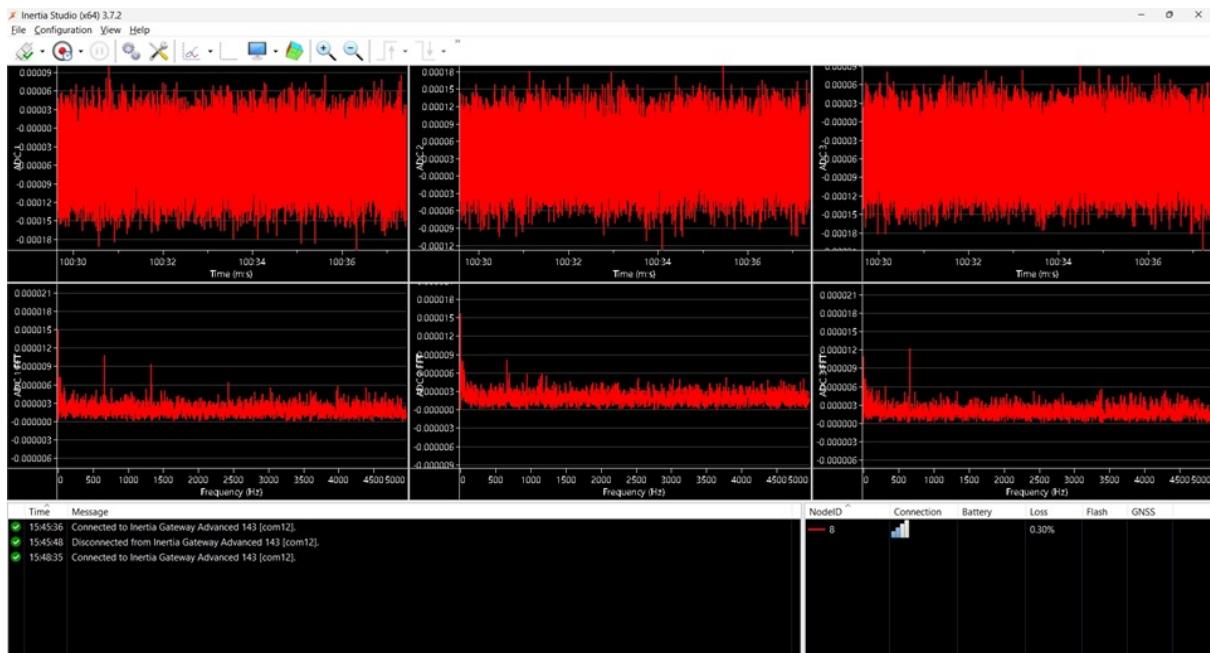

Figure 71: nexoDAQ signals from unconnected inputs

6. Configure the channels in Sensor Settings to ICP® (for details, see Section 2.6.5).

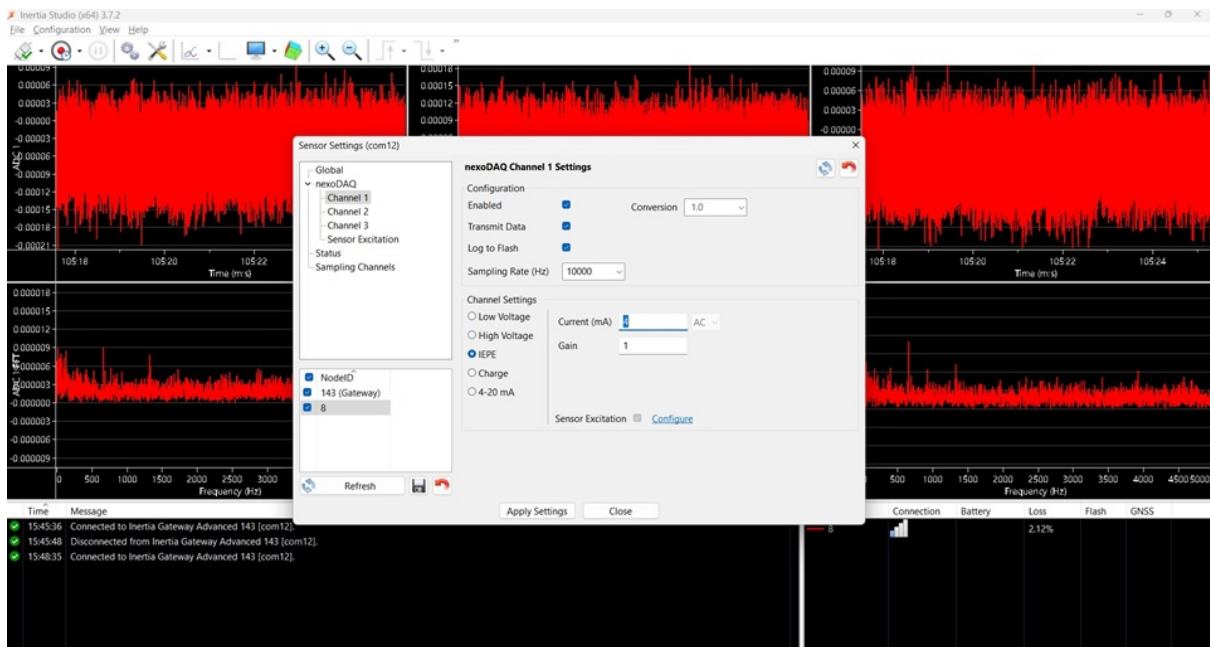

Figure 72: Configure ICP® channels in Inertia Studio

7. Connect the red *nexoDAQ* cables with the BNC end to the ICP® 3-axial sensor.

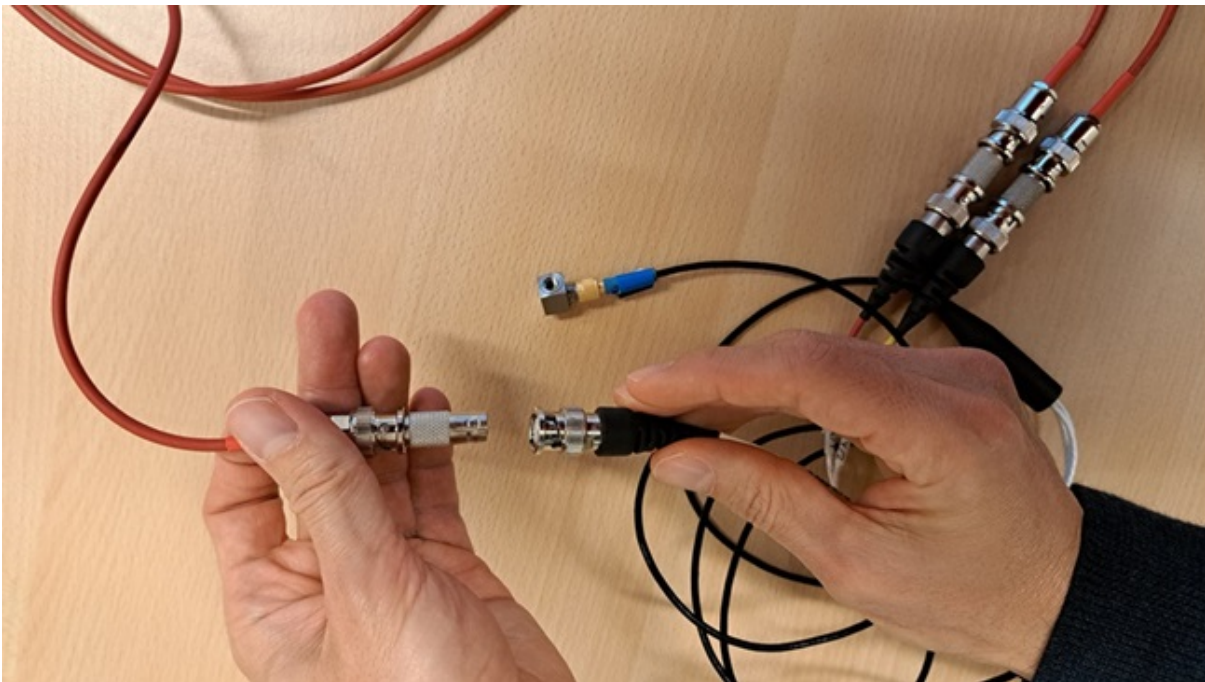

Figure 73: Connect the BNC connector of the red cable with the sensor BNC connector

8. Connect the red cables with the *Lemo* circular connector to the *nexoDAQ* channel inputs, by pushing the connector to the input of *nexoDAQ* with red dot of the connector up.



Figure 74: Connect the sensor to *nexoDAQ*



9. Signals from the ICP® 3-axis sensor the are coming in Inertia Studio.

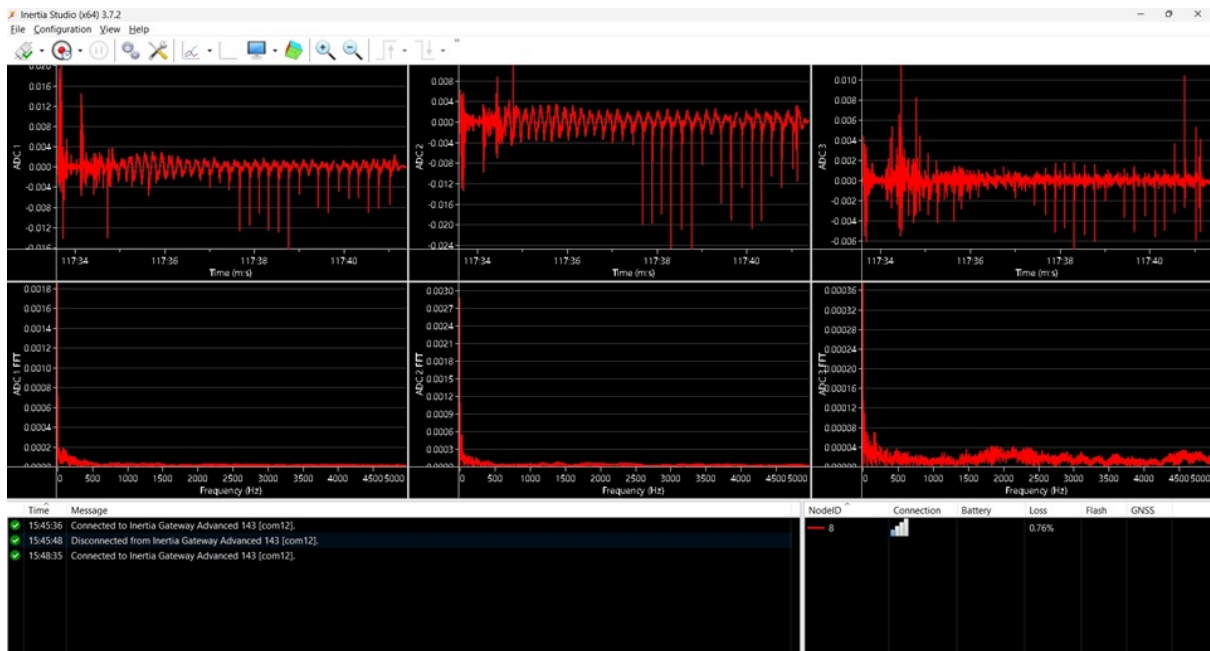

Figure 75: Signals from ICP® 3-axis sensor in Inertia Studio

10. You can now make a logfile (for details see Section 3.3).

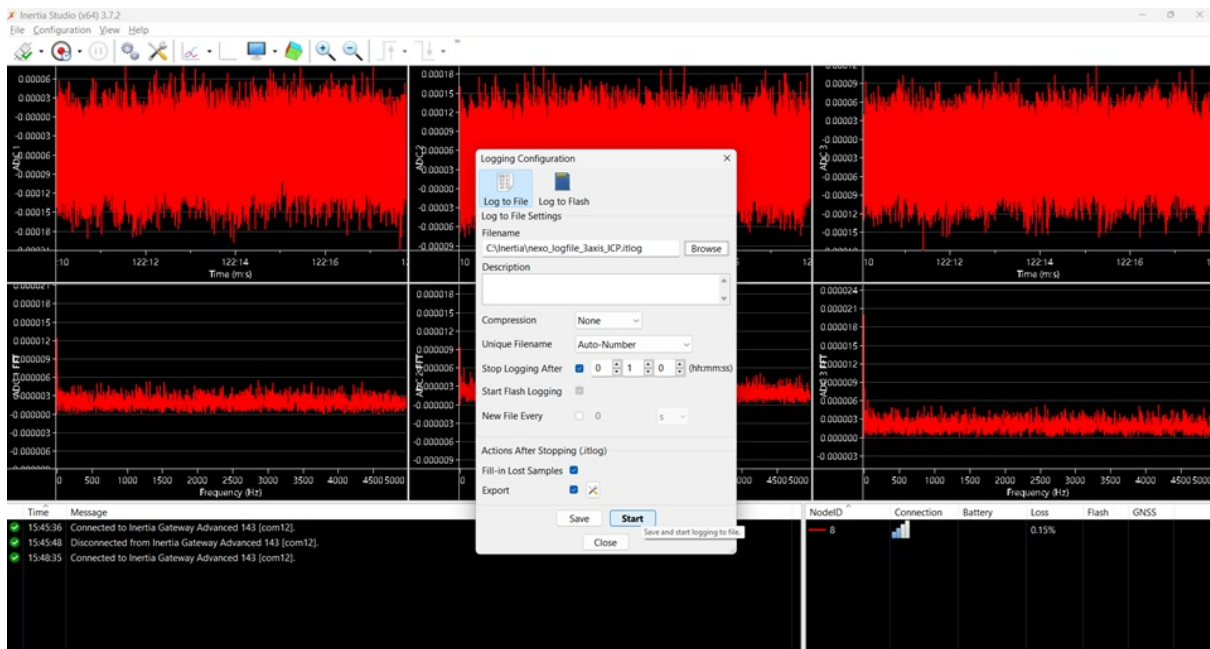

Figure 76: Make a logfile with Inertia Studio



4.2 Reading and Aligning CSV Log Files

Each line in the log file consists of a timestamp and sensor data sampled at that timestamp. A timestamp is the time in decimal seconds since the gateway was started. Figure 77 shows an example log file containing timestamps and sensor data from an experiment.

| timestamp | node-id | lostSamples | ax | ay | az | rssi |
|-----------|---------|-------------|----------|-----------|---------|------|
| 183.48 | 23 | 0 | 0.244209 | -0.174777 | 10.1993 | -52 |
| 183.485 | 23 | 0 | 0.258574 | -0.181959 | 10.1921 | -52 |
| 183.49 | 23 | 0 | 0.237026 | -0.179565 | 10.1873 | -52 |
| 183.495 | 23 | 0 | 0.253785 | -0.169988 | 10.2017 | -52 |
| 183.5 | 23 | 0 | 0.241814 | -0.189142 | 10.1825 | -52 |

Figure 77: Example of a log file

It is important to align the data from multiple nodes based on the timestamps. In a plot showing sensor data from multiple nodes, the timestamps should always represent the x axis. Figure 78 shows an example of acceleration data from multiple nodes aligned based on timestamps.

Please note that logs from multiple nodes can have different number of samples because the nodes could have started and stopped at slightly different times, they could have different sampling rates, there are lost samples, etc. This is not important, as long as the sensor data is aligned based on the timestamps.

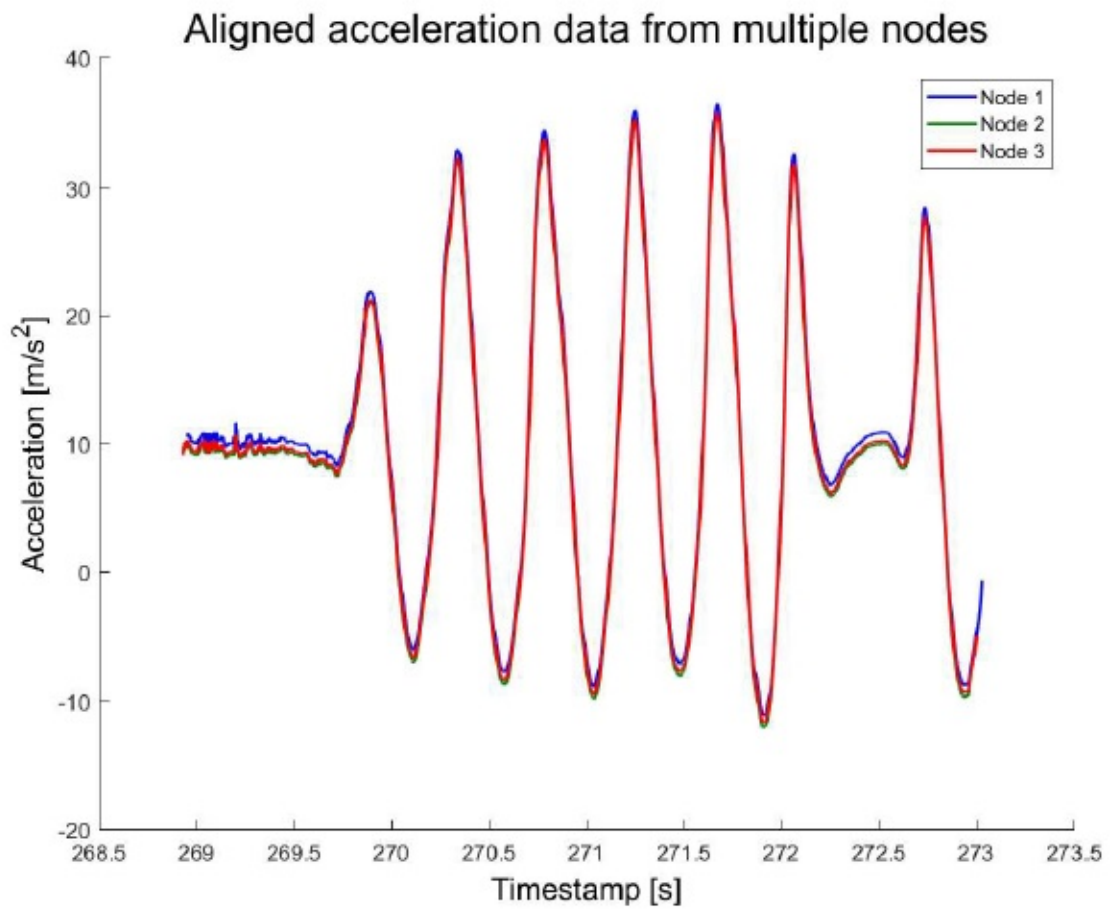

Figure 78: Example of aligned data from multiple nodes based on timestamps



5 Troubleshooting

5.1 Retrieving an Unreachable Device

If during network reconfiguration the communication with one device is lost and reconnection is not possible using the procedures described earlier in this manual, please refer to the following steps for device recovery:

1. Connect the device directly to the computer with a USB cable.
2. Click the *Capture* item from the *File* menu and select the serial port associated with the device from the drop-down list. Press the *Start* button.
3. Open the *Configuration* window from the *Options* menu and select *Global* in the sensor tree (see Section 3.8.1). Check the channel number. Change the channel if this doesn't match the configuration of the gateway. *Transmit Data* must be enabled for this device. A mismatch of the sampling rate can also result in sensor data missing in Inertia Studio. Note that unless the transmit type is set to *USB*, the data cannot be captured and shown directly from a wired device.

5.2 Slow Signals in Inertia Studio

When using multiple nodes, it is possible that the signals in Inertia Studio are displayed slower, and the software may start to lag. This is likely to be caused by drawing the plots, which is quite CPU-intensive. The following options are available to increase the performance.

5.2.1 Lowering the Plot Update Speed

The *Update Speed* of the signals in Inertia Studio can be lowered and the averaging for the *Down Sampling* can be increased, as described in paragraph 3.12.2.1 and paragraph 3.12.2.2.

5.2.2 Reducing the Number of Plots or Nodes

The layout wizard can be used to decrease the number of shown plots (see Section 3.12.1). Decreasing the number of plots lowers the load on the CPU. Reducing the number of nodes that are plotted at once (see Figure 3.1.1) can also improve performance.

5.2.3 Enabling Hardware Acceleration and Multi-threaded Rendering

Enabling hardware acceleration (see paragraph 3.12.2.2) will, in general, improve the performance by delegating some of the calculations to the GPU. Using multiple threads to render the plots reduces the load of the main thread and improves responsiveness of the user interface.



5.3 Manually Installing the Inertia Driver

If you are unable to install the Inertia Driver via the provided installer, the driver can be installed manually. The following steps describe this procedure for Windows.

1. Connect the Inertia device to the PC. Windows tries to find the correct driver, but fails.
2. Open the *Device Manager* from the *Start Menu* or *Control Panel*. Go to the *Universal Serial Bus controllers* section (ignore the faulty devices in *Other devices* and *Ports (COM & LPT)*).
3. Select and double click *USB Composite Device*. Verify it is the correct one. Go to the *Details* tab and select the *Hardware IDs* property. The value should contain *USB\VID_16D0&PID_090E*.
4. Go to the *Driver* tab and select *Update Driver*.
5. Select '*Browse my computer for drivers*', then select '*Let me pick from a list of available drivers on my computer*'.
6. A list with compatible hardware is shown. If it contains the latest *Inertia Driver*, select it. Otherwise, select *Have Disk...* and browse to the location containing *inertia.inf*. Select *OK* and *Next*.
7. The driver is now installed. The *USB Composite Device* and the faulty devices in *Other devices* and *Ports (COM & LPT)* should disappear, and an *Inertia Device* will appear in the *Ports (COM & LPT)* section.